

A photograph of the Aurora Borealis (Northern Lights) in a snowy, dark landscape at night. The aurora is a vibrant green and purple glow in the sky, reflecting on the snow. In the distance, there are some lights from buildings or structures.

# PRODUCT CATALOGUE

## SAUNA & STEAM

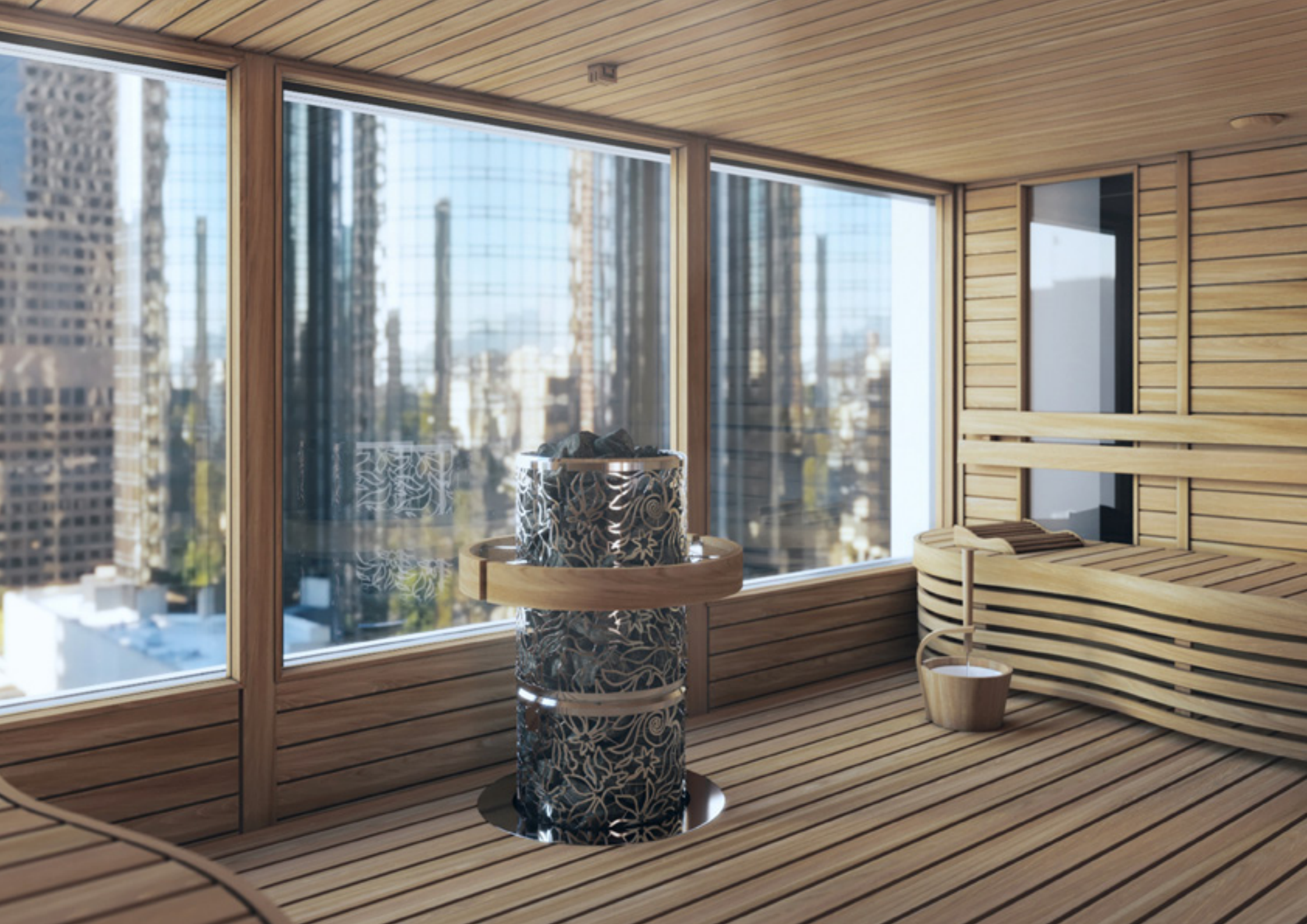





# Table of Contents

<b>About SAWO</b> .....	<b>4</b>		
<b>Sawo Dragonfire</b> .....	<b>5</b>		
Heaterking .....	6		
Junglefire .....	7		
Technical Data .....	8		
Sawo Dragonfire Accessories .....	11		
<b>Sauna Heaters</b> .....	<b>13</b>		
Ni2 Series .....	14		
Tower Series .....	15		
Tower Heater Guards & .....	20		
Integration Collars .....			
Stainless Series .....	22		
Stone Series .....	28		
Combi Series .....	29		
Fiber Coated .....	30		
Technical Data .....	31		
Heater Accessories .....	43		
<b>Controls</b> .....	<b>44</b>		
Heaters Controls .....	45		
Steam Generator Controls .....	47		
<b>Steam Generators</b> .....	<b>50</b>		
STE Steam Generator .....	51		
STN Steam Generator .....	52		
Technical Data .....	53		
Inclusions & Accessories .....	54		
		<b>Sauna Rooms</b> .....	<b>55</b>
		Glass Front .....	56
		Standard .....	60
		Wave .....	61
		Piano .....	62
		Classic .....	63
		Standard Layout .....	64
		Outdoor .....	67
		Customized .....	68
		<b>Infrared Sauna</b> .....	<b>69</b>
		<b>Sauna Accessories</b> .....	<b>72</b>
		Thermometers & Hygrometers .....	74
		Clocks & Sand Timers .....	76
		Pails & Ladles .....	76
		Doors & Handles .....	78
		Sauna Lights & Covers .....	82
		Headrest .....	82
		Backrest & Hangers .....	83
		Floor Mats & Benches .....	83
		Miscellaneous Items .....	83
		Pail Shower .....	84
		Kivistone .....	85

# About SAWO

## Nordic Wellness Lifestyle

Sauna is one essential part of Nordic Wellness Lifestyle. You may experience great joy for your health while relaxing in the sauna where sensuous warmth of the heat pamper your senses. We have created outstanding sauna and steam product selection for those delightful moments so anyone can enjoy the simple pleasures in everyday life.



## SAWO Inc.

For over 27 years SAWO has been one of the most established brands in sauna industry. Product range is expanded during the years into several categories to meet high demands of our clients. Today SAWO offers hundreds of different sauna and steam equipment models to fulfill conventional or commercial spa markets. This makes SAWO a reliable one-stop supplier for business partners all over the world.

## Quality & Environment

SAWO is highly emphasizing conservation of natural resources and constantly striving for being the most responsible sauna manufacturer on the market. SAWO products are produced with minimal waste as all the leftover materials are either reused or recycled. High quality wood materials for SAWO sauna rooms and accessories come from sustainable forests and environment certified suppliers.



# SAWO Dragonfire



Designed by world renowned Finnish designer Stefan Lindfors.



# HEATERKING

Heaterking heaters gives king size heat. Its long impressive shape holds massive amount of stones providing either sharp or smooth heat depending on spot where water is thrown. Unique stainless steel Junglefire-pattern design holds the stone pillar with style. Choose Round model for spacious saunas or Wall/Corner model for saunas with limited space.

! For more technical information, see page 8-9.



## Heaterking ROUND

- » Casing with intricate junglefire pattern
- » Stone spacer inside to prolong heating elements lifespan
- » Can fit from 60kg to 360kg of stones
- » 3kW - 24kW power
- » Round type
- » Separate control



## Heaterking WALL

- » Casing with intricate junglefire pattern
- » Stone spacer inside to prolong heating elements lifespan
- » Can fit from 60kg to 250kg of stones
- » 3kW - 24kW power
- » Wall type
- » Heat reflector included
- » Separate control



## Heaterking CORNER

- » Casing with intricate junglefire pattern
- » Stone spacer inside to prolong heating elements lifespan
- » Can fit from 45kg to 160kg of stones
- » 3kW - 12kW power
- » Corner type
- » Heat reflector included
- » Separate control



# JUNGLEFIRE

A long shape of Fiberjungle holds great amount of stones giving pleasant heat - Junglefire heat. Scandifire and Minidragon are smaller, wall mounted heaters with smooth and sensuous heat. All three heaters have unique fiber surface which provides protection against burnings. Therefore recommended especially for families with kids.

! For more technical information, see page 9-10.



## Fiberjungle

- » Fibercoated casing with junglefire pattern
- » Stone spacer inside to prolong heating elements lifespan
- » Floor standing
- » Can fit 60kg of stones
- » 4,5kW - 9kW power
- » Round type
- » Separate control



## Minidragon

- » Fibercoated casing with junglefire pattern
- » Wall mounted
- » Can fit 11kg of stones
- » 2,3kW - 3,6kW power
- » Built-in or separate control
- » Built-in models: Control knobs are with light indicator



## Scandifire

- » Fibercoated casing with junglefire pattern
- » Wall mounted
- » Can fit 22kg of stones
- » 4,5kW - 9kW power
- » Built-in or separate control
- » Built-in models: Control knobs are with light indicator



Heaterking ROUND

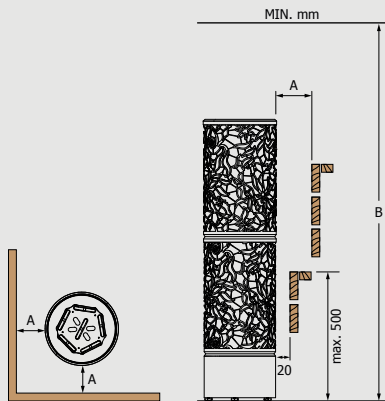

Minimum Safety Distances



Heaterking WALL

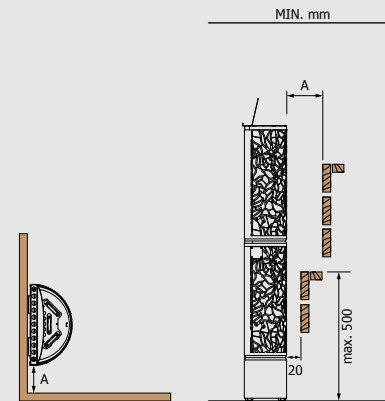

Minimum Safety Distances

Separate Control

HEATER MODEL	kW	SAUNA ROOM (m³)		SIZE OF HEATER (mm)			STONES (kg)		CONTROL	MINIMUM SAFETY DISTANCES (mm)	
		MIN	MAX	WIDTH	DEPTH	HEIGHT	Without Stone Spacer	With Stone Spacer		A	B
DRFT2-30NS	3,0	2	4	250	250	1325	70	60	separate	150	1900
DRFT3-35NS	3,5	3	6	250	250	1325	70	60	separate	100	1900
DRFT3-45NS	4,5	3	6	250	250	1325	70	60	separate	100	1900
DRFT3-60NS	6,0	5	8	250	250	1325	70	60	separate	150	1900
DRFT4-60NS	6,0	5	9	295	295	1325	105	90	separate	100	1900
DRFT5-80NS	8,0	7	13	295	295	1325	105	90	separate	200	1900
DRFT5-90NS	9,0	8	14	295	295	1325	105	90	separate	200	1900
DRFT6-80NS	8,0	7	14	355	355	1325	160	100	separate	100	1900
DRFT6-90NS	9,0	8	15	355	355	1325	160	100	separate	100	1900
DRFT6-105NS	10,5	9	16	355	355	1325	160	100	separate	150	1900
DRFT6-120NS	12,0	11	18	355	355	1325	160	100	separate	200	2100
DRFT9-105NS	10,5	10	16	425	425	1325	230	165	separate	150	2100
DRFT9-120NS	12,0	11	20	425	425	1325	230	165	separate	150	2100
DRFT9-150NS	15,0	14	25	425	425	1325	230	165	separate	200	2100
DRFT9-180NS	18,0	18	28	425	425	1325	230	165	separate	200	2100
DRFT12-150NS	15,0	15	26	525	525	1325	360	220	separate	200	2300
DRFT12-180NS	18,0	18	30	525	525	1325	360	220	separate	200	2300
DRFT12-210NS	21,0	22	35	525	525	1325	360	220	separate	200	2300
DRFT12-240NS	24,0	24	40	525	525	1325	360	220	separate	200	2300

Ni Version

HEATER MODEL	kW	SAUNA ROOM (m³)		SIZE OF HEATER (mm)			STONES (kg)		CONTROL	MINIMUM SAFETY DISTANCES (mm)	
		MIN	MAX	WIDTH	DEPTH	HEIGHT	Without Stone Spacer	With Stone Spacer		A	B
DRFT6-80Ni	8,0	7	14	355	355	1325	160	100	Built-in Innova	100	1900
DRFT6-90Ni	9,0	8	15	355	355	1325	160	100	Built-in Innova	100	1900
DRFT6-105Ni	10,5	9	16	355	355	1325	160	100	Built-in Innova	150	1900
DRFT6-120Ni	12,0	11	18	355	355	1325	160	100	Built-in Innova	200	2100
DRFT9-105Ni	10,5	10	16	425	425	1325	230	165	Built-in Innova	150	1900
DRFT9-120Ni	12,0	11	20	425	425	1325	230	165	Built-in Innova	150	2100
DRFT9-150Ni	15,0	14	25	425	425	1325	230	165	Built-in Innova	200	2100
DRFT9-180Ni	18,0	18	28	425	425	1325	230	165	Built-in Innova	200	2300
DRFT12-150Ni	15,0	15	26	525	525	1325	360	220	Built-in Innova	200	2300
DRFT12-180Ni	18,0	18	30	525	525	1325	360	220	Built-in Innova	200	2300
DRFT12-210Ni	21,0	22	35	525	525	1325	360	220	Built-in Innova	200	2300
DRFT12-240Ni	24,0	24	40	525	525	1325	360	220	Built-in Innova	200	2300

Separate Control

HEATER MODEL	kW	SAUNA ROOM (m³)		SIZE OF HEATER (mm)			STONES (kg)		CONTROL	MINIMUM SAFETY DISTANCES (mm)	
		MIN	MAX	WIDTH	DEPTH	HEIGHT	Without Stone Spacer	With Stone Spacer		A	B
DRFT3-35NS-WL	3,5	3	6	395	*220	1450	80	60	separate	100	1900
DRFT3-45NS-WL	4,5	3	6	395	*220	1450	80	60	separate	100	1900
DRFT3-60NS-WL	6,0	5	8	395	*220	1450	80	60	separate	100	1900
DRFT6-80NS-WL	8,0	7	14	545	*300	1465	160	105	separate	100	1900
DRFT6-90NS-WL	9,0	8	15	545	*300	1465	160	105	separate	100	1900
DRFT6-105NS-WL	10,5	9	16	545	*300	1465	160	105	separate	100	1900
DRFT6-120NS-WL	12,0	11	18	545	*300	1465	160	105	separate	100	2100
DRFT9-105NS-WL	10,5	10	16	650	*350	1510	180	115	separate	100	2100
DRFT9-120NS-WL	12,0	11	20	650	*350	1510	180	115	separate	100	2100
DRFT9-150NS-WL	15,0	14	25	650	*350	1510	180	115	separate	100	2100
DRFT9-180NS-WL	18,0	18	28	650	*350	1510	180	115	separate	100	2100
DRFT12-150NS-WL	15,0	15	26	790	*420	1555	250	165	separate	100	2300
DRFT12-180NS-WL	18,0	18	30	790	*420	1555	250	165	separate	100	2300
DRFT12-210NS-WL	21,0	22	35	790	*420	1555	250	165	separate	100	2300
DRFT12-240NS-WL	24,0	24	40	790	*420	1555	250	165	separate	100	2300

Ni Version

HEATER MODEL	kW	SAUNA ROOM (m³)		SIZE OF HEATER (mm)			STONES (kg)		CONTROL	MINIMUM SAFETY DISTANCES (mm)	
		MIN	MAX	WIDTH	DEPTH	HEIGHT	Without Stone Spacer	With Stone Spacer		A	B
DRFT6-80Ni-WL	8,0	7	14	545	*300	1465	160	105	Built-in Innova	100	1900
DRFT6-90Ni-WL	9,0	8	15	545	*300	1465	160	105	Built-in Innova	100	1900
DRFT6-105Ni-WL	10,5	9	16	545	*300	1465	160	105	Built-in Innova	100	1900
DRFT6-120Ni-WL	12,0	11	18	545	*300	1465	160	105	Built-in Innova	100	2100
DRFT9-105Ni-WL	10,5	10	16	650	*350	1510	180	115	Built-in Innova	100	1900
DRFT9-120Ni-WL	12,0	11	20	650	*350	1510	180	115	Built-in Innova	100	2100
DRFT9-150Ni-WL	15,0	14	25	650	*350	1510	180	115	Built-in Innova	100	2100
DRFT9-180Ni-WL	18,0	18	28	650	*350	1510	180	115	Built-in Innova	100	2100
DRFT12-150Ni-WL	15,0	15	26	790	*420	1545	250	165	Built-in Innova	100	2300
DRFT12-180Ni-WL	18,0	18	30	790	*420	1545	250	165	Built-in Innova	100	2300
DRFT12-210Ni-WL	21,0	22	35	790	*420	1545	250	165	Built-in Innova	100	2300
DRFT12-240Ni-WL	24,0	24	40	790	*420	1545	250	165	Built-in Innova	100	2300

\*Depth when installed to the wall.



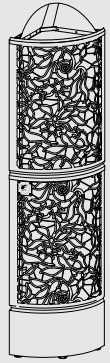

Heaterking CORNER

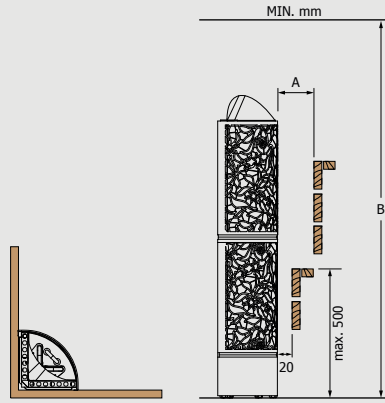

Minimum Safety Distances



FIBERJUNGLE

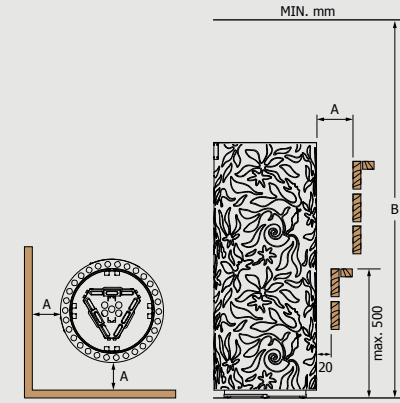

Minimum Safety Distances

Separate Control

HEATER MODEL	kW	SAUNA ROOM		SIZE OF HEATER			STONES		CONTROL	MINIMUM SAFETY DISTANCES	
		MIN (m³)	MAX (m³)	WIDTH (mm)	DEPTH (mm)	HEIGHT (mm)	Without Stone Spacer (kg)	With Stone Spacer (kg)		A	B
DRFT3-35NS-CNR	3,5	3	6	300	*300	1395	70	45	separate	100	1900
DRFT3-45NS-CNR	4,5	3	6	300	*300	1395	70	45	separate	100	1900
DRFT3-60NS-CNR	6,0	5	8	300	*300	1395	70	45	separate	100	1900
DRFT6-80NS-CNR	8,0	7	14	410	*410	1415	160	80	separate	100	1900
DRFT6-90NS-CNR	9,0	8	15	410	*410	1415	160	80	separate	100	1900
DRFT6-105NS-CNR	10,5	9	16	410	*410	1415	160	80	separate	100	1900
DRFT6-120NS-CNR	12,0	11	18	410	*410	1415	160	80	separate	100	2100

\*Depth when installed to the wall.

Separate Control

HEATER MODEL	kW	SAUNA ROOM		SIZE OF HEATER			STONES (kg)	CONTROL	MINIMUM SAFETY DISTANCES	
		MIN (m³)	MAX (m³)	WIDTH (mm)	DEPTH (mm)	HEIGHT (mm)			A	B
DRF3-45NS	4,5	3	6	365	365	930	60	separate	100	1900
DRF3-60NS	6,0	5	9	365	365	930	60	separate	100	1900
DRF3-75NS	7,5	7	13	365	365	930	60	separate	100	1900
DRF3-90NS	9,0	8	14	365	365	930	60	separate	100	1900



**MINIDRAGON**

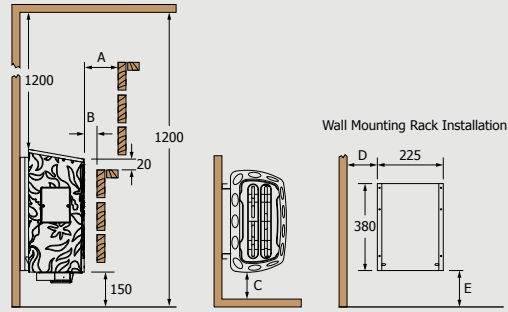

**Minimum Safety Distances**

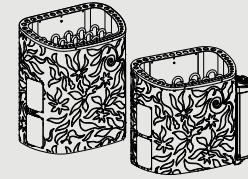

**SCANDIFIRE**

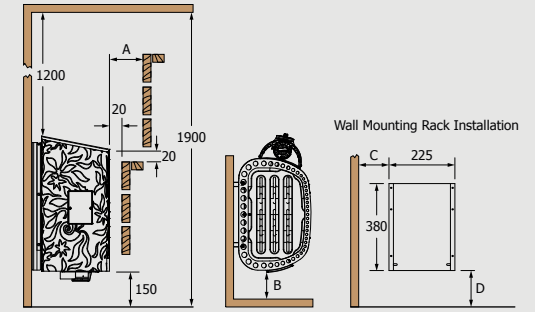

**Minimum Safety Distances**

**Built-in Control**

HEATER MODEL	kW	SAUNA ROOM		SIZE OF HEATER			STONES (kg)	CONTROL	MINIMUM SAFETY DISTANCES				
		MIN (m <sup>2</sup> )	MAX	WIDTH	DEPTH (mm)	HEIGHT			A	B	C	D	E
MN-23NB-DRF / MN-23NB-DRF-BL	2,3	1,3	2,5	435	*215	455	8 - 11	built-in	50	20	40	140	155
MN-30NB-DRF / MN-30NB-DRF-BL	3,0	2	4	435	*215	455	8 - 11	built-in	60	20	50	140	155
MN-36NB-DRF / MN-36NB-DRF-BL	3,6	3	6	435	*215	455	8 - 11	built-in	90	20	80	140	155

**Separate Control**

HEATER MODEL	kW	SAUNA ROOM		SIZE OF HEATER			STONES (kg)	CONTROL	MINIMUM SAFETY DISTANCES				
		MIN (m <sup>2</sup> )	MAX	WIDTH	DEPTH (mm)	HEIGHT			A	B	C	D	E
MN-23NS-DRF / MN-23NS-DRF-BL	2,3	1,3	2,5	335	*215	455	8 - 11	separate	50	20	40	90	155
MN-30NS-DRF / MN-30NS-DRF-BL	3,0	2	4	335	*215	455	8 - 11	separate	60	20	50	90	155
MN-36NS-DRF / MN-36NS-DRF-BL	3,6	3	6	335	*215	455	8 - 11	separate	90	20	50	90	155

*\*Depth when installed to the wall.*

**Built-in Control**

HEATER MODEL	kW	SAUNA ROOM		SIZE OF HEATER			STONES (kg)	CONTROL	MINIMUM SAFETY DISTANCES			
		MIN (m <sup>2</sup> )	MAX	WIDTH	DEPTH (mm)	HEIGHT			A	B	C	D
SCA-45NB-DRF / SCA-45NB-DRF-BL	4,5	3	6	515	*290	455	18-22	built-in	50	50	185	155
SCA-60NB-DRF / SCA-60NB-DRF-BL	6,0	5	8	515	*290	455	18-22	built-in	50	50	185	155
SCA-80NB-DRF / SCA-80NB-DRF-BL	8,0	7	13	515	*290	525	18-22	built-in	100	100	185	235
SCA-90NB-DRF / SCA-90NB-DRF-BL	9,0	8	14	515	*290	525	18-22	built-in	100	100	185	235

**Separate Control**

HEATER MODEL	kW	SAUNA ROOM		SIZE OF HEATER			STONES (kg)	CONTROL	MINIMUM SAFETY DISTANCES			
		MIN (m <sup>2</sup> )	MAX	WIDTH	DEPTH (mm)	HEIGHT			A	B	C	D
SCA-45NS-DRF / SCA-45NS-DRF-BL	4,5	3	6	410	*290	455	18-22	separate	60	50	135	155
SCA-60NS-DRF / SCA-60NS-DRF-BL	6,0	5	8	410	*290	455	18-22	separate	60	50	135	155
SCA-80NS-DRF / SCA-80NS-DRF-BL	8,0	7	13	410	*290	525	18-22	separate	60	50	135	235
SCA-90NS-DRF / SCA-90NS-DRF-BL	9,0	8	14	410	*290	525	18-22	separate	60	50	135	235

*\*Depth when installed to the wall.*



## Firemeter



- » Thermometer
- » Celsius and Fahrenheit
- » Round and easy to hang
- » Metal or red color

## Steamwater



- » 4L or 9L Water bucket
- » Laser-engraved junglefire pattern on the entire pail's surface
- » Plastic insert included
- » Ergonomic handle
- » Top coated cedar or black color

## Steamshot



- » Free-standing ladle
- » Top coated cedar or black color handle
- » Stainless or red coated cap



## Firecontrol

- » LCD touch screen heater control
- » Brushed stainless steel casing
- » Sets time, temperature, light, fan and steamer

## Technical DATA

CONTROL	
Rated Power 3 Phases	15 kW AC1 (3 x 5 kW)
Rated Voltage 3 Phases	400V 3N~
Rated Power Single Phase	9 kW AC1
Rated Voltage Single Phase	230V 1N~
Frequency	50/60Hz
Switching capacity per phase	21A
Sauna temperature range	10 - 110°C
Maximum session time (preset)	4, 6, 12, 18, 24h Restrictions apply according to IEC/EN 60335-2-53
Temperature Sensor with fuse	Regulating temperature max.110°C

OPTIONAL FEATURES	
Dimmer	Only for dimmable lights, (ex: incandescent bulbs)
Fan	Fan without starting capacitor (with speed control)
Rating	230V 1N~, 0,5A
Steamer	Max, 5 kW
Rated Power 3 Phases	5 kW AC1
Rated Power Single Phase	3 kW AC1
Rated Voltage	230V 1N~
Switching capacity	21A (3 Phases), 13A (1 Phase)
Maximum sauna temperature for steamer operation	80°C or 55°C (Depending on the type of Sensor 2)
Automatic water filling	Applicable for SAWO Combi Heaters with Auto Refill
Automatic drain valve	Applicable when autodrain is present
Bench Temperature Sensor	
Bench Combined Temperature Humidity Sensor	

CONTACTOR UNIT	ADDITIONAL
Rated Power 3 Phases	15 kW AC1 (3 x 5 kW) Power expansion to maximum of 30 kW
Rated Voltage 3 Phases	400V 3N~
Frequency	50/60Hz
Switching capacity per phase	21A



# Sauna HEATERS

Throw water to hot stones and release the spirit  
of sauna.



# Ni2 Heaters

Sauna heaters with **Saunova 2.0** control.

Now, built-in control heaters are equipped with multi-level sauna functions! They have several useful features with handy settings to adjust.

Ni2 Heaters are using Saunova 2.0 control which has a smart heat controlling that alternately switch off a heating element when set temperature is reached. This process will save energy and reduces temperature fluctuations that keeps heating elements to work in a balance pace.

The Saunova 2.0 user interface can be installed inside or outside the sauna room.



**TOWER Ni2**  
(Round,Wall,Corner)



**ARIES Ni2**  
(Round,Wall,Corner)



**PHOENIX Ni2**



**CUBOS Ni2**



**KRIOS Ni2**



**NORDEX Series Ni2**  
(Plus,Mini,Combi)



**NORDEX Ni2**  
(Nordex,Combi)



**CUMULUS Ni2**

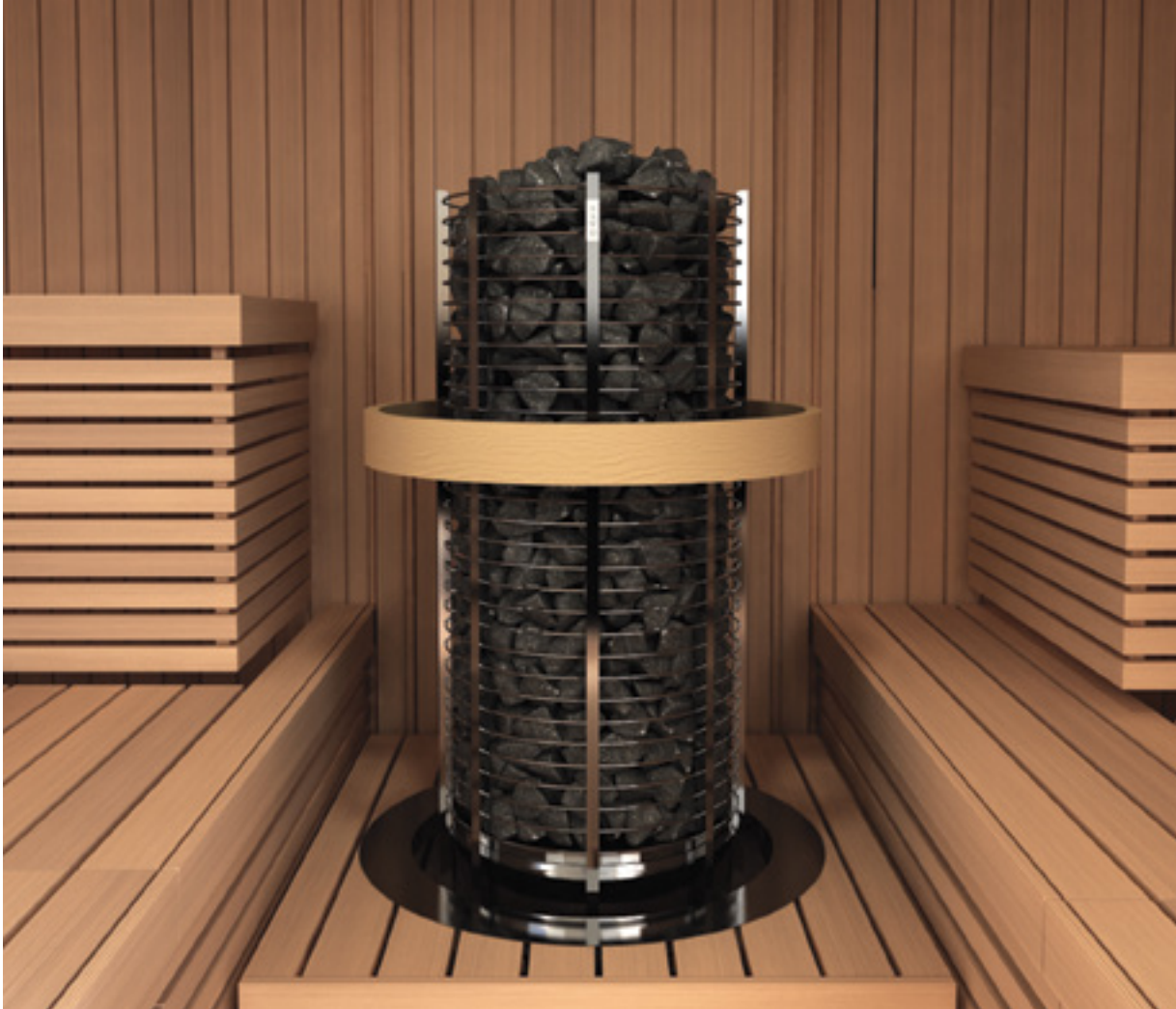

# TOWER Series

Tower heater is best described as a “sauna stone pillar”. Strong, stainless steel rings hold massive amount of stones. The design is developed to produce steam from the lowest to the highest part of the sauna room.

⚠ For more technical information, see page 31-35.



## Tower ROUND

- » Metal rings hold the stones
- » Stone spacer inside to prolong heating elements lifespan
- » Floor standing
- » Can fit from 60kg to 360kg of stones
- » 3kW - 24kW power
- » Built-in, separate or innova embedded control
- » Round type
- » Built-in models: Control knobs are with light indicator
- » Adjustable legs



## Tower WALL

- » Metal rings hold the stones
- » Stone spacer inside to prolong heating elements lifespan
- » Heat reflector included
- » Floor standing
- » Can fit from 60kg to 250kg of stones
- » 3kW - 24kW power
- » Built-in, separate or innova embedded control
- » Wall type
- » Built-in models: Control knobs are with light indicator
- » Adjustable legs



## Tower CORNER

- » Metal rings hold the stones
- » Stone spacer inside to prolong heating elements lifespan
- » Heat reflector included
- » Floor standing
- » Can fit from 45kg to 160kg of stones
- » 3kW - 12kW power
- » Built-in, separate or innova embedded control
- » Corner type
- » Built-in models: Control knobs are with light indicator
- » Adjustable legs

# CUBOS Heater

Cubos is 3 in 1 heater! It can be placed in the middle, corner or wall of the sauna room. Additional protective covers will add support for wall and corner installation. This modern and versatile heater is one of a kind.

Cubos is also available with Saunova 2.0 control (Ni2). Ni2 heaters are effortless to install, easy and energy-efficient to use. Perfect choice for modern saunas.

! For more technical information, see page 32.

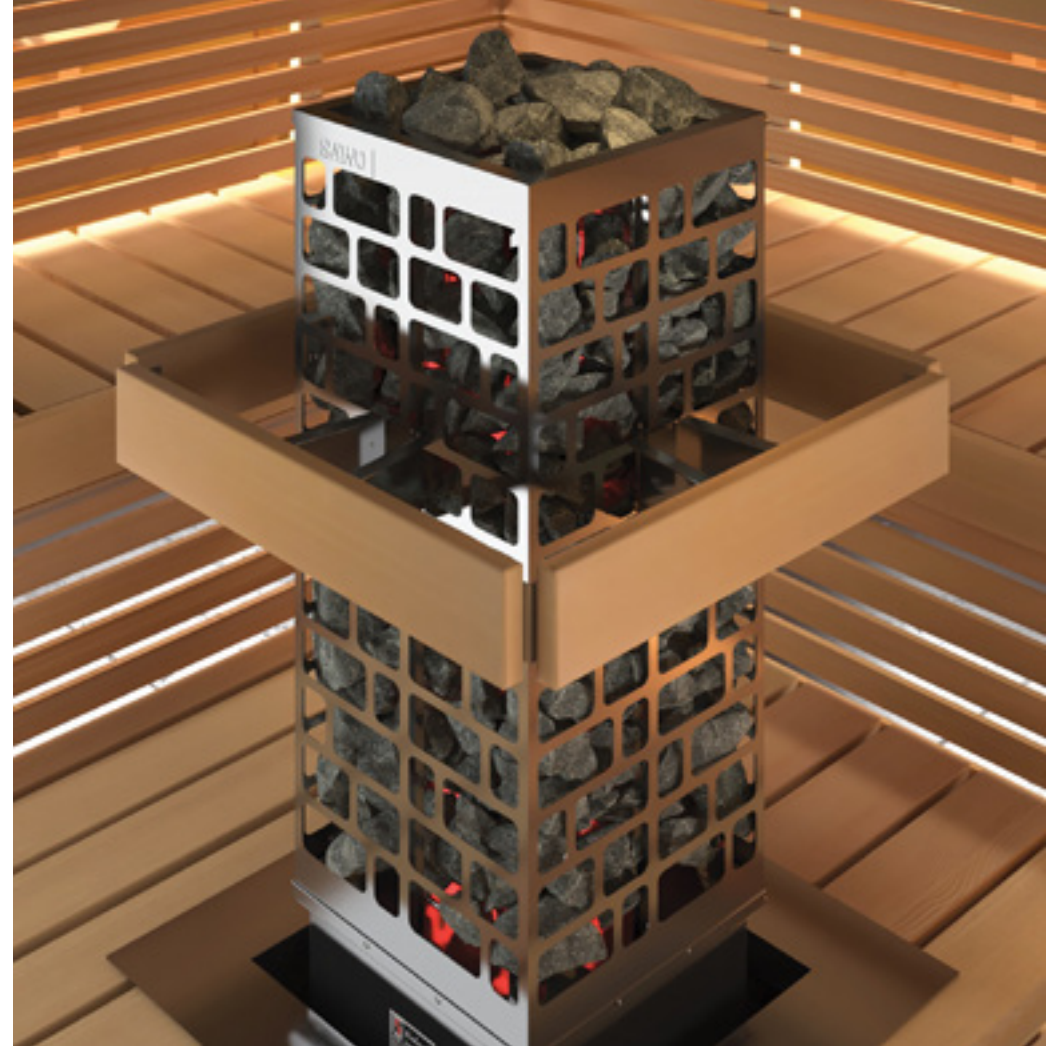

Saunova 2.0 Operated  
(Ni2)

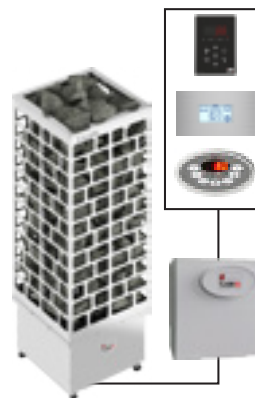

Separate  
(NS)



Built-in Control  
(NB)



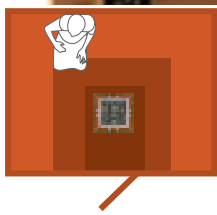

Middle Installation

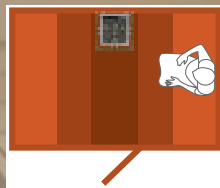

Wall Installation  
with Protective Cover

Cubos is a versatile heater with 3 different installation options. By adding **Cubos Protective Cover**, the cubos heater can be transformed to Wall or Corner heater.

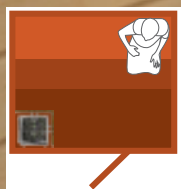

Corner Installation  
with Protective Cover



## Cubos

- » **3 in 1 heater** (middle, wall and corner installation)
- » Sturdy stainless steel casing
- » Stone spacer inside to prolong heating elements lifespan
- » Floor standing
- » Can fit up to 75kg of stones
- » 4,5kW - 9kW power
- » Built-in, separate or Ni2 control
- » Adjustable legs



## Protective Cover Accessory

### Wall Installation

Use Cubos Protective Cover for wall installation. Best for sauna designs with limited space. The set of the protective cover for wall includes covering sheet and a reflector that directs heat even to lowest parts of the sauna room.

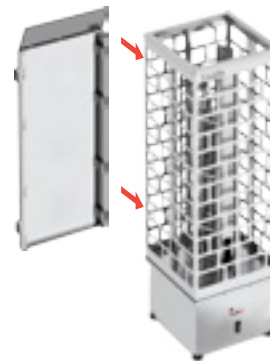

Wall Installation  
with Protective Cover

### Corner Installation

Cubos quickly changes to corner model with Protective Cover for corner. Corner installation saves space and enables using different bench designs. The protective cover for corner set includes two pieces of covering sheet, a connection rod and a heat reflector.

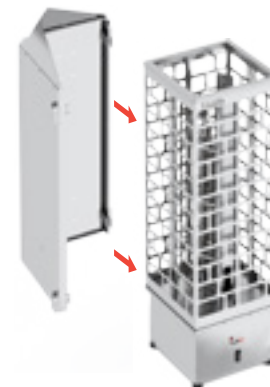

Corner Installation  
with Protective Cover



## Phoenix

- » Stainless tubes hold the stones
- » Stone spacer inside to prolong heating elements lifespan
- » Floor standing
- » Can fit from 85kg to 130kg of stones
- » 4,5kW - 18kW power
- » Separate, Ni2 control
- » Adjustable legs



## Orion

- » Stainless tubes hold the stones
- » Stone spacer inside to prolong heating elements lifespan
- » Cassette-type heating elements holder for easy maintenance
- » Floor standing
- » Can fit 210kg of stones
- » 9kW - 12kW power
- » Separate control
- » Adjustable legs





## Aries ROUND

- » Stainless steel casing
- » Stone spacer inside to prolong heating elements lifespan
- » Floor standing
- » Can fit from 60kg to 110kg of stones
- » 4,5kW - 18kW power
- » Built-in, separate or Ni2 control
- » Round type
- » Adjustable legs



## Aries WALL

- » Stainless steel casing
- » Stone spacer inside to prolong heating elements lifespan
- » Heat reflector included
- » Floor standing
- » Can fit 65kg of stones
- » 4,5kW - 9kW power
- » Built-in, separate or Ni2 control
- » Wall type
- » Adjustable legs



## Aries CORNER

- » Stainless steel casing
- » Stone spacer inside to prolong heating elements lifespan
- » Heat reflector included
- » Floor standing
- » Can fit 65kg of stones
- » 4,5kW - 9kW power
- » Built-in, separate or Ni2 control
- » Corner type
- » Adjustable legs



# TOWER Heater GUARDS & Integration COLLARS

Heater guards are precautionary measure against accidental contact with the heater while integration collars add accent and beauty to your sauna interior. Guard rails are made from Cedar or Aspen wood and are mounted to the heater. Integration collars are available either from thick hair lined stainless steel, soft soapstones or from strong laminated wood. All of them has a design to fit for Round, Wall and Corner Tower heaters!



Wooden Guard Rail



Soapstone  
Integration Collar



Stainless  
Integration Collar

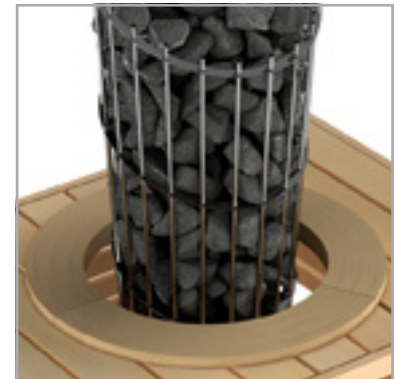

Wooden  
Integration Collar

# Technical DATA

## WOODEN Guard Rail

Cube (CUB) | Tower (TH) | Aries (ARI)



Round

MODEL	SIZE OF GUARD RAIL		
	WIDTH (mm)	DEPTH (mm)	HEIGHT (mm)
TH-GUARD-W2-DJA	510	510	90
TH-GUARD-W4-DJA	560	560	90
TH-GUARD-W6-DJA	620	620	90
TH-GUARD-W9-DJA	690	690	90
TH-GUARD-W12-DJA	790	790	90
ARI-GUARD-W3-DJA	550	550	90
ARI-GUARD-W6-DJA	690	690	90
CUB-GUARD-W3-DJA	550	550	90



Wall

MODEL	SIZE OF GUARD RAIL		
	WIDTH (mm)	DEPTH (mm)	HEIGHT (mm)
TH-GUARD-W2-WL-DJA	615	340	90
TH-GUARD-W4-WL-DJA	720	395	90
TH-GUARD-W6-WL-DJA	795	435	90
TH-GUARD-W9-WL-DJA	895	485	90
TH-GUARD-W12-WL-DJA	1035	555	90
ARI-GUARD-W3-WL-DJA	665	365	90
CUB-GUARD-W3-WL-DJA	1035	555	90



Corner

MODEL	SIZE OF GUARD RAIL		
	WIDTH (mm)	DEPTH (mm)	HEIGHT (mm)
TH-GUARD-W2-CNR-DJA	580	375	90
TH-GUARD-W4-CNR-DJA	660	465	90
TH-GUARD-W6-CNR-DJA	745	525	90
ARI-GUARD-W3-CNR-DJA	635	160	90
CUB-GUARD-W3-CNR-DJA	745	525	90

Krios (KRI) | Helius (HES) | Taurus (TAU)



HEATERS
TH2, TH3
TH4 & TH5
TH6
TH9
TH12
ARI3
ARI6
CUB3

MODEL	SIZE OF GUARD RAIL		
	WIDTH (mm)	DEPTH (mm)	HEIGHT (mm)
KRI-GUARD-W-DJA	630	385	90
HES-GUARD-W-DJA	510	510	90
TAU-GUARD-W9-DJA	560	560	90
TAU-GUARD-W15-DJA	620	620	90
TAU-GUARD-W-V12-DJA	690	690	90

HEATERS
KRI-45, KRI-60, KRI-80, KRI-90
HES-45, HES-60, HES-75, HES-90
TAU-90, TAU-105, TAU-120
TAU-150, TAU-180
TAU-180-V12, TAU-210-V12, TAU-240-V12

## SOAPSTONE Integration Collar

Cube (CUB) | Tower (TH) | Aries (ARI)



Round

MODEL	SIZE OF COLLAR		
	WIDTH (mm)	DEPTH (mm)	HEIGHT (mm)
TH-COLLAR-S2	510	510	45
TH-COLLAR-S4	560	560	45
TH-COLLAR-S6	620	620	45
TH-COLLAR-S9	690	690	45
TH-COLLAR-S12	790	790	45
CUB-COLLAR-S3	690	690	45



Wall

MODEL	SIZE OF COLLAR		
	WIDTH (mm)	DEPTH (mm)	HEIGHT (mm)
TH-COLLAR-S2-WL	630	345	45
TH-COLLAR-S4-WL	720	390	45
TH-COLLAR-S6-WL	790	425	45
TH-COLLAR-S9-WL	890	475	45
TH-COLLAR-S12-WL	1030	545	45
CUB-COLLAR-S3-WL	890	475	45



Corner

MODEL	SIZE OF COLLAR		
	WIDTH (mm)	DEPTH (mm)	HEIGHT (mm)
TH-COLLAR-S2-CNR	425	425	45
TH-COLLAR-S4-CNR	480	480	45
TH-COLLAR-S6-CNR	540	540	45
CUB-COLLAR-S3-CNR	480	480	45

HEATERS
TH2, TH3
TH4, TH5, ARI3 & PNX3
TH6
TH9, ARI6 & PNX6
TH12, ORN
CUB3

## STAINLESS Integration Collar

Cube (CUB) | Tower (TH) | Aries (ARI)



Round

MODEL	SIZE OF COLLAR		
	WIDTH (mm)	DEPTH (mm)	HEIGHT (mm)
TH-COLLAR-ST2	460	460	45
TH-COLLAR-ST4	540	540	45
TH-COLLAR-ST6	640	640	45
TH-COLLAR-ST9	720	720	45
TH-COLLAR-ST12	820	820	45
CUB-COLLAR-ST3	720	720	45



Wall

MODEL	SIZE OF COLLAR		
	WIDTH (mm)	DEPTH (mm)	HEIGHT (mm)
TH-COLLAR-ST2-WL	650	355	45
TH-COLLAR-ST4-WL	700	380	45
TH-COLLAR-ST6-WL	830	445	45
TH-COLLAR-ST9-WL	880	470	45
TH-COLLAR-ST12-WL	1010	535	45
CUB-COLLAR-ST3-WL	880	470	45



Corner

MODEL	SIZE OF COLLAR		
	WIDTH (mm)	DEPTH (mm)	HEIGHT (mm)
TH-COLLAR-ST2-CNR	435	435	45
TH-COLLAR-ST4-CNR	480	480	45
TH-COLLAR-ST6-CNR	525	525	45
CUB-COLLAR-ST3-CNR	480	480	45

HEATERS
TH2, TH3
TH4, TH5, ARI3 & PNX3
TH6
TH9, ARI6 & PNX6
TH12, ORN
CUB3

## WOODEN Integration Collar

Cube (CUB) | Tower (TH) | Aries (ARI)



Round

MODEL	SIZE OF COLLAR		
	WIDTH (mm)	DEPTH (mm)	HEIGHT (mm)
TH-COLLAR-W2-DJA	510	510	45
TH-COLLAR-W4-DJA	560	560	45
TH-COLLAR-W6-DJA	620	620	45
TH-COLLAR-W9-DJA	690	690	45
TH-COLLAR-W12-DJA	790	790	45
CUB-COLLAR-W3-DJA	690	690	45



Wall

MODEL	SIZE OF COLLAR		
	WIDTH (mm)	DEPTH (mm)	HEIGHT (mm)
TH-COLLAR-W2-WL-DJA	630	345	45
TH-COLLAR-W4-WL-DJA	720	390	45
TH-COLLAR-W6-WL-DJA	790	425	45
TH-COLLAR-W9-WL-DJA	890	475	45
TH-COLLAR-W12-WL-DJA	1030	545	45
CUB-COLLAR-W3-WL-DJA	890	475	45



Corner

MODEL	SIZE OF COLLAR		
	WIDTH (mm)	DEPTH (mm)	HEIGHT (mm)
TH-COLLAR-W2-CNR-DJA	425	425	45
TH-COLLAR-W4-CNR-DJA	480	480	45
TH-COLLAR-W6-CNR-DJA	540	540	45
CUB-COLLAR-W3-CNR-DJA	480	480	45

HEATERS
TH2, TH3
TH4, TH5, ARI3 & PNX3
TH6
TH9, ARI6 & PNX6
TH12, ORN
CUB3



# STAINLESS Series

SAWO Stainless Heaters are traditional Finnish electric sauna heaters made from robust stainless steel. The Stainless Series includes everything from Mini heaters, suitable for small sauna rooms, to heavy-duty Taurus heaters for large and frequently used commercial saunas.

⚠ For more technical information, see page 35-40.



## Mini

- » Wall mounted
- » Best for small-sized sauna rooms
- » Controls can be transferred from right to left (NB Model)
- » Optional heat reflector
- » Can fit 11kg of stones
- » 2,3kW - 3,6kW power
- » Built-in, separate control, fiber coated or combi model (with steamer)
- » Built-in models: Control knobs are with light indicator



## Mini X

- » Wall mounted in straight or corner position
- » Best for small-sized sauna rooms
- » Can fit 11kg of stones
- » 2,3kW - 3,6kW power
- » Built-in, separate control or fiber coated model
- » Built-in models: Control knobs are with light indicator



## Scandia

- » Wall mounted
- » For medium-sized sauna rooms
- » Controls can be transferred from right to left (NB Model)
- » Optional heat reflector
- » Can fit 22kg of stones
- » 4,5kW - 9kW power
- » Built-in, separate control, fiber coated or combi model (with steamer)
- » Built-in models: Control knobs are with light indicator



# KRIOS

## Heating In Style

This beautiful wall-mounted heater has stainless steel casing with signature SAWO-pattern. Inspired by Aries and Cubos models, this heater is something you have never seen before.

With more stones, Krios gives more steam. Perfect especially for small and medium sized saunas to bring smooth and humid heat.

ⓘ For more technical information, see page 37.



Saunova 2.0 Operated  
(Ni2)



Separate  
(NS)



Built-in Control  
(NB)



## Krios

- » Wall mounted
- » Stainless steel casing
- » Heat reflector included
- » Control can be rotated to left, front and right
- » Can fit 50kg of stones
- » 4,5kW - 9,0kW power
- » Built-in, separate, Ni2 control



## Nordex

- » Wall mounted
- » Simple, minimalist design
- » Heat reflector included
- » Control can be rotated to left, front and right
- » Can fit 22kg of stones
- » 4,5kW - 9,0kW power
- » Built-in, separate, Ni2 control, combi model (with steamer)







## Helius

- » Floor standing
- » Stones are not in contact with heating elements
- » Water accessory is included for recess wall installation
- » Can fit 17kg of stones
- » 4,5kW - 9kW power
- » Catch pan included
- » Separate control
- » Adjustable legs



## Taurus

- » Minimal safety distance required
- » Floor standing
- » Traditional or G Type version (stones are not in contact with heating elements)
- » Can fit from 45kg to 100kg of stones
- » 9kW - 24kW power
- » Catch pan included
- » Recommended for commercial sauna rooms
- » LED indicator for busted heating elements
- » Cassette-type heating elements holder for easy maintenance
- » Separate control
- » Adjustable legs



Savonia NB



Savonia NS

## Savonia

- » Floor standing
- » Recommended for commercial sauna rooms
- » Can fit from 40kg to 100kg of stones
- » 9kW - 24kW power
- » Built-in, separate control, fiber coated or combi model (with steamer)
- » Built-in models: Control knobs are with light indicator
- » Adjustable leg support





### Nordex Mini

- » Wall mounted in straight or corner position
- » Simple, minimalist design
- » Heat reflector included
- » Can fit 11kg of stones
- » 2,3kW - 3,6kW power
- » Built-in, separate, Ni2 control
- » Detachable combi-tank (optional)



### Nordex Plus

- » Wall mounted
- » Simple, minimalist design
- » Heat reflector included
- » Control can be rotated to left, front and right
- » Can fit 22kg of stones
- » 4,5kW - 9,0kW power
- » Built-in, separate, Ni2 control
- » Detachable combi-tank (optional)



### Nordex Floor

- » Floor standing
- » Simple, minimalist design
- » Can fit from 40kg to 100kg of stones
- » 9,0kW - 24kW power
- » Separate control

# STONE Series

SAWO Stone Heaters are made from a combination of stainless steel and heat-conducting Finnish soapstone which dries up the sauna room fast after use. From SAWO Stone Series you can find a heater suitable for every kind of sauna room. Power rating of Stone Heaters is from 3 kW up to 24 kW.

! For more technical information, see page 41-42.



## Nimbus

- » Floor standing
- » Soapstone covered casing
- » Corner top stones are engraved as aroma basins
- » Can fit from 40kg to 100kg of stones
- » 9kW - 24kW power
- » Separate control or combi model (with steamer)
- » Adjustable legs



Cirrus

Cirrus ROCK

## Cirrus & Cirrus Rock

- » Wall mounted
- » Cirrus: Soapstone front cover
- » Cirrus Rock: Sauna stones filled front
- » Front cover use: shift from Cirrus Rock to Cirrus
- » Adjustable tilting angle from the wall mounting sheet
- » Tandem connection can be used if wanting to double the kW capacity
- » Can fit from 23kg to 34kg of soapstones and 6kg to 65kg of sauna stones
- » 3kW - 9kW power
- » Built-in or separate control
- » Built-in models: Control knobs are with light indicator



## Cumulus

- » Wall mounted
- » Front is with soapstone covering
- » Heat reflector included
- » Control can be rotated to left, front and right
- » 10kg of soapstones and 22kg of stones
- » 4,5kW - 9kW power
- » Built-in, separate, Ni2 control
- » Built-in models: Control knobs are with light indicator



# COMBI Series

Combi heaters are electric heaters with an integrated steamer which allows you to choose between normal sauna to steam sauna. Combi heaters are equipped with scent basins for aroma oil and patented Water Level Detection System that warns when water level is low. \*Water level can easily be monitored through water level indicator tube.

- » Nordex Mini Combi
- » Nordex Combi
- » Mini Combi\*
- » Scandia Combi\*
- » Savonia Combi\*
- » Nimbus Combi

ⓘ For more technical information, see page 35-41.



Nordex Mini COMBI  
» Detachable combi-tank



Nordex COMBI  
» Detachable combi-tank



Mini COMBI



Scandia COMBI



Savonia COMBI



Nimbus COMBI

# FIBER Coated

SAWO Stainless and Combi heaters are available with optional fiber coating. In addition to their classy appearance, fiber coating protects bathers from accidental burnings.

- » Fiber coated Mini, Mini Combi
- » Fiber coated Mini X
- » Fiber coated Scandia, Scandia Combi
- » Fiber coated Savonia, Savonia Combi



Fiber Coated MINI



Fiber Coated MINI X



Fiber Coated SCANDIA



Fiber Coated SAVONIA

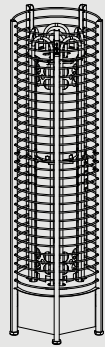

Tower ROUND

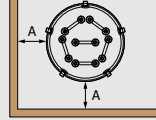

Minimum Safety Distances

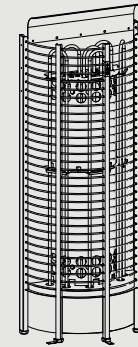
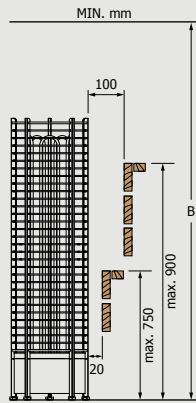

Tower WALL

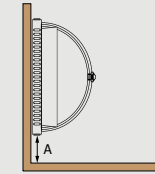

Minimum Safety Distances

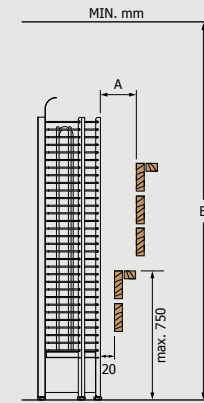

Built-in | Separate Control

HEATER MODEL	kW	SAUNA ROOM		SIZE OF HEATER			STONES		CONTROL	MINIMUM SAFETY DISTANCES	
		MIN	MAX	WIDTH	DEPTH	HEIGHT	Without Stone Spacer	With Stone Spacer		A	B
TH2-30 NB NS	3,0	2	4	260	260	1300	70	60	built-in separate	150 150	1900
TH3-35 NB NS	3,5	3	6	260	260	1300	70	60	built-in separate	150 100	1900
TH3-45 NB NS	4,5	3	6	260	260	1300	70	60	built-in separate	150 100	1900
TH3-60 NB NS	6,0	5	8	260	260	1300	70	60	built-in separate	150 150	1900
TH4-60 NB NS	6,0	5	9	315	315	1300	105	90	built-in separate	150 150	1900
TH5-80 NB NS	8,0	7	13	315	315	1300	105	90	built-in separate	100 100	1900
TH5-90NS	9,0	8	14	315	315	1300	105	90	separate	150	1900
TH6-80 NB NS	8,0	7	14	365	365	1300	160	100	built-in separate	100 100	1900
TH6-90 NB NS	9,0	8	15	365	365	1300	160	100	built-in separate	100 100	1900
TH6-105NS	10,5	9	16	365	365	1300	160	100	separate	150	1900
TH6-120NS	12,0	11	18	365	365	1300	160	100	separate	200	2100
TH9-105NS	10,5	10	16	450	450	1300	230	165	separate	150	2100
TH9-120NS	12,0	11	20	450	450	1300	230	165	separate	150	2100
TH9-150NS	15,0	14	25	450	450	1300	230	165	separate	200	2100
TH9-180NS	18,0	18	28	450	450	1300	230	165	separate	200	2100
TH12-150NS	15,0	15	26	545	545	1300	360	220	separate	200	2300
TH12-180NS	18,0	18	30	545	545	1300	360	220	separate	200	2300
TH12-210NS	21,0	22	35	545	545	1300	360	220	separate	200	2300
TH12-240NS	24,0	24	40	545	545	1300	360	220	separate	200	2300

Ni Version

HEATER MODEL	kW	SAUNA ROOM		SIZE OF HEATER			STONES		CONTROL	MINIMUM SAFETY DISTANCES	
		MIN	MAX	WIDTH	DEPTH	HEIGHT	Without Stone Spacer	With Stone Spacer		A	B
TH2-30Ni2	3,0	2	4	260	260	1300	70	60	Saunova	100	1900
TH3-35Ni2	3,5	3	6	260	260	1300	70	60	Saunova	100	1900
TH3-45Ni2	4,5	3	6	260	260	1300	70	60	Saunova	100	1900
TH3-60Ni2	6,0	5	8	260	260	1300	70	60	Saunova	150	1900
TH4-60Ni2	6,0	5	9	315	315	1300	105	90	Saunova	150	1900
TH5-80Ni2	8,0	8	14	315	315	1300	105	90	Saunova	150	1900
TH5-90Ni2	9,0	8	14	315	315	1300	105	90	Saunova	150	1900
TH6-80Ni2	8,0	7	14	365	365	1300	160	100	Saunova	150	1900
TH6-90Ni2	9,0	8	15	365	365	1300	160	100	Saunova	150	1900
TH6-105Ni2	10,5	9	16	365	365	1300	160	100	Built-in Innova	150	1900
TH6-120Ni2	12,0	11	18	365	365	1300	160	100	Built-in Innova	200	2100
TH9-105Ni2	10,5	10	16	450	450	1300	230	165	Built-in Innova	150	2100
TH9-120Ni2	12,0	11	20	450	450	1300	230	165	Built-in Innova	150	2100
TH9-150Ni2	15,0	14	25	450	450	1300	230	165	Built-in Innova	200	2100
TH9-180Ni2	18,0	18	28	450	450	1300	230	165	Built-in Innova	200	2100
TH12-150Ni2	15,0	15	26	545	545	1300	360	220	Built-in Innova	200	2300
TH12-180Ni2	18,0	18	30	545	545	1300	360	220	Built-in Innova	200	2300
TH12-210Ni2	21,0	22	35	545	545	1300	360	220	Built-in Innova	200	2300
TH12-240Ni2	24,0	24	40	545	545	1300	360	220	Built-in Innova	200	2300

Built-in | Separate Control

HEATER MODEL	kW	SAUNA ROOM		SIZE OF HEATER			STONES		CONTROL	MINIMUM SAFETY DISTANCES	
		MIN	MAX	WIDTH	DEPTH	HEIGHT	Without Stone Spacer	With Stone Spacer		A	B
TH2-30 NB NS-WL	3,0	2	4	385	*230	1395	80	60	built-in separate	100	1900
TH3-35 NB NS-WL	3,5	3	6	385	*230	1395	80	60	built-in separate	100	1900
TH3-45 NB NS-WL	4,5	3	6	385	*230	1395	80	60	built-in separate	100	1900
TH3-60 NB NS-WL	6,0	5	8	385	*230	1395	80	60	built-in separate	100	1900
TH4-60 NB NS-WL	6,0	5	9	475	*250	1395	120	90	built-in separate	100	1900
TH5-80 NB NS-WL	8,0	7	13	475	*250	1395	120	90	built-in separate	100	1900
TH5-90NS-WL	9,0	8	14	475	*250	1395	120	90	separate	100	1900
TH6-80 NB NS-WL	8,0	7	14	550	*320	1395	160	105	built-in separate	100	1900
TH6-90 NB NS-WL	9,0	8	15	550	*320	1395	160	105	built-in separate	100	1900
TH6-105NS-WL	10,5	9	16	550	*320	1395	160	105	separate	100	2100
TH6-120NS-WL	12,0	11	18	550	*320	1395	160	105	separate	100	2100
TH9-105NS-WL	10,5	10	16	650	*355	1395	180	115	separate	100	2100
TH9-120NS-WL	12,0	11	20	650	*355	1395	180	115	separate	100	2100
TH9-150NS-WL	15,0	14	25	650	*355	1395	180	115	separate	100	2100
TH9-180NS-WL	18,0	18	28	650	*355	1395	180	115	separate	100	2300
TH12-150NS-WL	15,0	15	26	790	*425	1395	250	165	separate	100	2300
TH12-180NS-WL	18,0	18	30	790	*425	1395	250	165	separate	100	2300
TH12-210NS-WL	21,0	22	35	790	*425	1395	250	165	separate	100	2300
TH12-240NS-WL	24,0	24	40	790	*425	1395	250	165	separate	100	2300

Ni Version

HEATER MODEL	kW	SAUNA ROOM		SIZE OF HEATER			STONES		CONTROL	MINIMUM SAFETY DISTANCES	
		MIN	MAX	WIDTH	DEPTH	HEIGHT	Without Stone Spacer	With Stone Spacer		A	B
TH2-30Ni2-WL	3,0	2	4	385	*230	1395	80	60	Saunova	100	1900
TH3-35Ni2-WL	3,5	3	6	385	*230	1395	80	60	Saunova	100	1900
TH3-45Ni2-WL	4,5	3	6	385	*230	1395	80	60	Saunova	100	1900
TH3-60Ni2-WL	6,0	5	8	385	*230	1395	80	60	Saunova	100	1900
TH4-60Ni2-WL	6,0	5	9	475	*250	1395	120	90	Saunova	100	1900
TH5-80Ni2-WL	8,0	8	14	475	*250	1395	120	90	Saunova	100	1900
TH5-90Ni2-WL	9,0	8	14	475	*250	1395	120	90	Saunova	100	1900
TH6-80Ni2-WL	8,0	7	14	550	*320	1395	160	105	Saunova	100	1900
TH6-90Ni2-WL	9,0	8	15	550	*320	1395	160	105	Saunova	100	1900
TH6-105Ni2-WL	10,5	9	16	550	*320	1395	160	105	Built-in Innova	100	1900
TH6-120Ni2-WL	12,0	11	18	550	*320	1395	160	105	Built-in Innova	100	2100
TH9-105Ni2-WL	10,5	10	16	650	*355	1395	180	115	Built-in Innova	100	2100
TH9-120Ni2-WL	12,0	11	20	650	*355	1395	180	115	Built-in Innova	100	2100
TH9-150Ni2-WL	15,0	14	25	650	*355	1395	180	115	Built-in Innova	100	2100
TH12-150Ni2-WL	15,0	15	26	790	*425	1395	250	165	Built-in Innova	100	2300
TH12-180Ni2-WL	18,0	18	30	790	*425	1395	250	165	Built-in Innova	100	2300
TH12-210Ni2-WL	21,0	22	35	790	*425	1395	250	165	Built-in Innova	100	2300
TH12-240Ni2-WL	24,0	24	40	790	*425	1395	250	165	Built-in Innova	100	2300

\*Depth when installed to the wall.



Tower CORNER

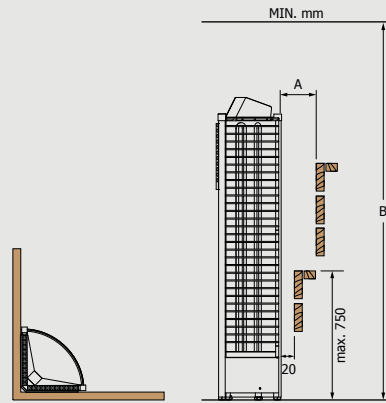

Minimum Safety Distances

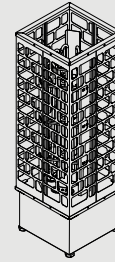

Cubos

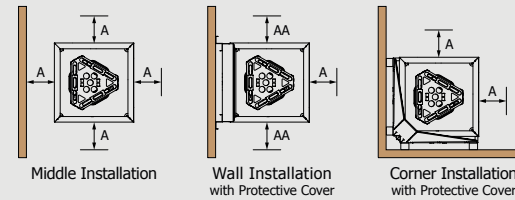

Minimum Safety Distances

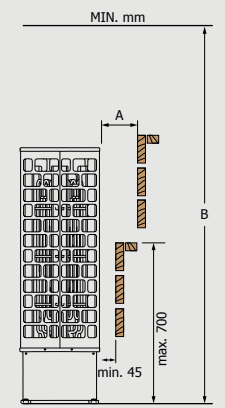

Built-in Control

HEATER MODEL	kW	SAUNA ROOM		SIZE OF HEATER			STONES		CONTROL	MINIMUM SAFETY DISTANCES	
		MIN (m³)	MAX	WIDTH	DEPTH	HEIGHT	Without Stone Spacer	With Stone Spacer (kg)		A	B
TH2-30NB-CNR	3,0	2	4	300	*300	1380	70	45	built-in	125	1900
TH3-35NB-CNR	3,5	3	6	300	*300	1380	70	45	built-in	125	1900
TH3-45NB-CNR	4,5	3	6	300	*300	1380	70	45	built-in	125	1900
TH3-60NB-CNR	6,0	5	8	300	*300	1380	70	45	built-in	125	1900
TH4-60NB-CNR	6,0	5	9	355	*355	1380	105	70	built-in	125	1900
TH5-80NB-CNR	8,0	7	13	355	*355	1380	105	70	built-in	125	1900
TH6-80NB-CNR	8,0	7	14	415	*415	1380	160	80	built-in	125	1900
TH6-90NB-CNR	9,0	8	15	415	*415	1380	160	80	built-in	125	1900

Separate Control

HEATER MODEL	kW	SAUNA ROOM		SIZE OF HEATER			STONES		CONTROL	MINIMUM SAFETY DISTANCES	
		MIN (m³)	MAX	WIDTH	DEPTH	HEIGHT	Without Stone Spacer	With Stone Spacer (kg)		A	B
TH2-30NS-CNR	3,0	2	4	300	*300	1380	70	45	separate	100	1900
TH3-35NS-CNR	3,5	3	6	300	*300	1380	70	45	separate	100	1900
TH3-45NS-CNR	4,5	3	6	300	*300	1380	70	45	separate	100	1900
TH3-60NS-CNR	6,0	5	8	300	*300	1380	70	45	separate	100	1900
TH4-60NS-CNR	6,0	5	9	355	*355	1380	105	70	separate	100	1900
TH5-80NS-CNR	8,0	7	13	355	*355	1380	105	70	separate	100	1900
TH5-90NS-CNR	9,0	8	14	355	*355	1380	105	70	separate	100	1900
TH6-80NS-CNR	8,0	7	14	415	*415	1380	160	80	separate	100	1900
TH6-90NS-CNR	9,0	8	15	415	*415	1380	160	80	separate	100	1900
TH6-105NS-CNR	10,5	9	16	415	*415	1380	160	80	separate	100	1900
TH6-120NS-CNR	12,0	11	18	415	*415	1380	160	80	separate	100	2100

Ni Version

HEATER MODEL	kW	SAUNA ROOM		SIZE OF HEATER			STONES		CONTROL	MINIMUM SAFETY DISTANCES	
		MIN (m³)	MAX	WIDTH	DEPTH	HEIGHT	Without Stone Spacer	With Stone Spacer (kg)		A	B
TH2-30Ni2-CNR	3,0	2	4	300	*300	1380	70	45	Saunova	100	1900
TH3-35Ni2-CNR	3,5	3	6	300	*300	1380	70	45	Saunova	100	1900
TH3-45Ni2-CNR	4,5	3	6	300	*300	1380	70	45	Saunova	100	1900
TH3-60Ni2-CNR	6,0	5	8	300	*300	1380	70	45	Saunova	100	1900
TH4-60Ni2-CNR	6,0	5	9	355	*355	1380	105	70	Saunova	100	1900
TH5-80Ni2-CNR	8,0	7	13	355	*355	1380	105	70	Saunova	100	1900
TH5-90Ni2-CNR	9,0	8	14	355	*355	1380	105	70	Saunova	100	1900
TH6-80Ni2-CNR	8,0	7	14	415	*415	1380	160	80	Saunova	100	1900
TH6-90Ni2-CNR	9,0	8	15	415	*415	1380	160	80	Saunova	100	1900
TH6-105Ni-CNR	10,5	9	16	415	*415	1380	160	80	Built-in Innova	100	1900
TH6-120Ni-CNR	12,0	11	18	415	*415	1380	160	80	Built-in Innova	100	2100

\*Depth when installed to the wall.

Built-in Control

HEATER MODEL	kW	SAUNA ROOM		SIZE OF HEATER (mm)						STONES (kg)	CONTROL	MINIMUM SAFETY DISTANCES			
		MIN	MAX	MIDDLE		WALL		CORNER				HEIGHT	A	AA	B
CUB3-45NB	4,5	3	6	290	290	290	340	340	340	930	75	built-in	100	100	1900
CUB3-60NB	6,0	5	9	290	290	290	340	340	340	930	75	built-in	100	100	1900
CUB3-75NB	7,5	7	13	290	290	290	340	340	340	930	75	built-in	100	135	1900
CUB3-90NB	9,0	8	14	290	290	290	340	340	340	930	75	built-in	125	135	1900

Separate Control

HEATER MODEL	kW	SAUNA ROOM		SIZE OF HEATER (mm)						STONES (kg)	CONTROL	MINIMUM SAFETY DISTANCES			
		MIN	MAX	MIDDLE		WALL		CORNER				HEIGHT	A	AA	B
CUB3-45NS	4,5	3	6	290	290	290	340	340	340	930	75	separate	100	100	1900
CUB3-60NS	6,0	5	9	290	290	290	340	340	340	930	75	separate	100	100	1900
CUB3-75NS	7,5	7	13	290	290	290	340	340	340	930	75	separate	100	135	1900
CUB3-90NS	9,0	8	14	290	290	290	340	340	340	930	75	separate	125	135	1900

Ni2 Version

HEATER MODEL	kW	SAUNA ROOM		SIZE OF HEATER (mm)						STONES (kg)	CONTROL	MINIMUM SAFETY DISTANCES			
		MIN	MAX	MIDDLE		WALL		CORNER				HEIGHT	A	AA	B
CUB3-45Ni2	4,5	3	6	290	290	290	340	340	340	930	75	Saunova 2.0	100	100	1900
CUB3-60Ni2	6,0	5	9	290	290	290	340	340	340	930	75	Saunova 2.0	100	100	1900
CUB3-75Ni2	7,5	7	13	290	290	290	340	340	340	930	75	Saunova 2.0	100	135	1900
CUB3-90Ni2	9,0	8	14	290	290	290	340	340	340	930	75	Saunova 2.0	125	135	1900



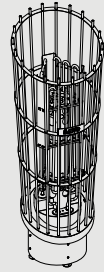

Phoenix

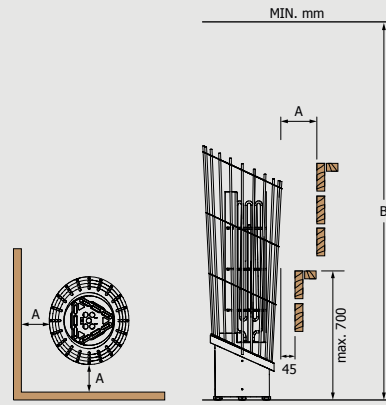

Minimum Safety Distances

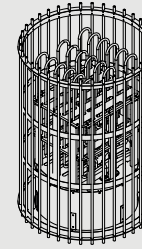

Orion

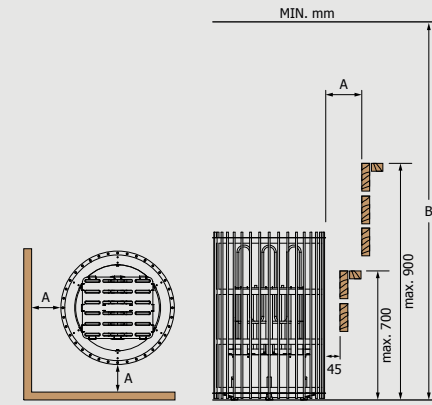

Minimum Safety Distances

Separate Control

HEATER MODEL	kW	SAUNA ROOM		SIZE OF HEATER			STONES (kg)	CONTROL	MINIMUM SAFETY DISTANCES	
		MIN (m³)	MAX (m³)	WIDTH	DEPTH (mm)	HEIGHT			A	B
PNX3-45NS	4,5	3	6	375	340	1100	85	separate	100	1900
PNX3-60NS	6,0	5	9	375	340	1100	85	separate	125	1900
PNX3-75NS	7,5	7	13	375	340	1100	85	separate	125	1900
PNX3-90NS	9,0	8	14	375	340	1100	85	separate	150	1900
PNX6-90NS	9,0	8	15	525	475	1175	130	separate	150	1900
PNX6-105NS	10,5	9	16	525	475	1175	130	separate	150	1900
PNX6-120NS	12,0	11	18	525	475	1175	130	separate	150	2100
PNX6-150NS	15,0	14	25	525	475	1175	130	separate	150	2100
PNX6-180NS	18,0	18	28	525	475	1175	130	separate	175	2100

Separate Control

HEATER MODEL	kW	SAUNA ROOM		SIZE OF HEATER			STONES (kg)	CONTROL	MINIMUM SAFETY DISTANCES	
		MIN (m³)	MAX (m³)	WIDTH	DEPTH (mm)	HEIGHT			A	B
ORN-90NS	9,0	8	14	575	575	980	210	separate	125	1900
ORN-105NS	10,5	9	15	575	575	980	210	separate	130	1900
ORN-120NS	12,0	10	18	575	575	980	210	separate	135	1900

Ni2 Version

HEATER MODEL	kW	SAUNA ROOM		SIZE OF HEATER			STONES (kg)	CONTROL	MINIMUM SAFETY DISTANCES	
		MIN (m³)	MAX (m³)	WIDTH	DEPTH (mm)	HEIGHT			A	B
PNX3-45Ni2	4,5	3	6	375	340	1100	85	Saunova	100	1900
PNX3-60Ni2	6,0	5	9	375	340	1100	85	Saunova	125	1900
PNX3-75Ni2	7,5	7	13	375	340	1100	85	Saunova	125	1900
PNX3-90Ni2	9,0	8	14	375	340	1100	85	Saunova	150	1900
PNX6-90Ni2	9,0	8	15	525	475	1175	130	Saunova	150	1900

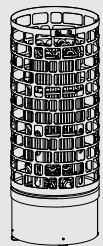

Aries ROUND

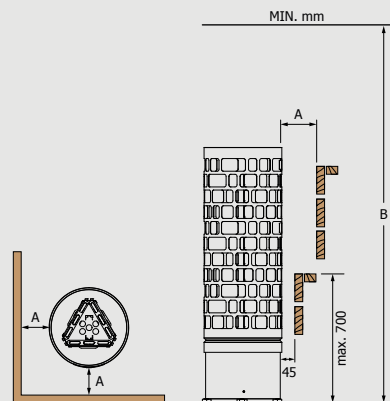

Minimum Safety Distances



Aries WALL

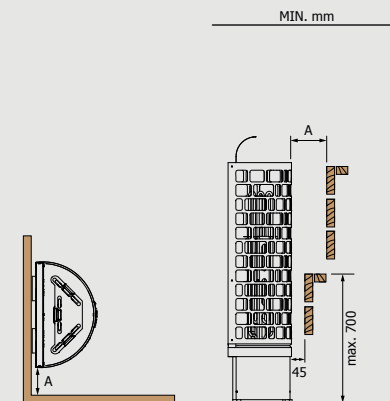

Minimum Safety Distances

Built-in Control

HEATER MODEL	kW	SAUNA ROOM		SIZE OF HEATER			STONES (kg)	CONTROL	MINIMUM SAFETY DISTANCES	
		MIN (m³)	MAX	WIDTH	DEPTH (mm)	HEIGHT			A	B
ARI3-45NB	4,5	3	6	300	300	930	60	built-in	100	1900
ARI3-60NB	6,0	5	8	300	300	930	60	built-in	100	1900
ARI3-75NB	7,5	7	12	300	300	930	60	built-in	100	1900
ARI3-90NB	9,0	8	14	300	300	930	60	built-in	100	1900
ARI6-90NB	9,0	8	15	440	440	930	110	built-in	100	1900

Built-in Control

HEATER MODEL	kW	SAUNA ROOM		SIZE OF HEATER			STONES (kg)	CONTROL	MINIMUM SAFETY DISTANCES	
		MIN (m³)	MAX	WIDTH	DEPTH (mm)	HEIGHT			A	B
ARI3-45NB-WL	4,5	3	6	415	*250	1030	65	built-in	100	1900
ARI3-60NB-WL	6,0	5	8	415	*250	1030	65	built-in	100	1900
ARI3-75NB-WL	7,5	7	12	415	*250	1030	65	built-in	100	1900
ARI3-90NB-WL	9,0	8	14	415	*250	1030	65	built-in	100	1900

Separate Control

HEATER MODEL	kW	SAUNA ROOM		SIZE OF HEATER			STONES (kg)	CONTROL	MINIMUM SAFETY DISTANCES	
		MIN (m³)	MAX	WIDTH	DEPTH (mm)	HEIGHT			A	B
ARI3-45NS	4,5	3	6	300	300	930	60	separate	100	1900
ARI3-60NS	6,0	5	8	300	300	930	60	separate	100	1900
ARI3-75NS	7,5	7	12	300	300	930	60	separate	100	1900
ARI3-90NS	9,0	8	14	300	300	930	60	separate	100	1900
ARI6-90NS	9,0	8	15	440	440	930	110	separate	100	1900
ARI6-105NS	10,5	9	16	440	440	930	110	separate	100	1900
ARI6-120NS	12,0	10	18	440	440	930	110	separate	100	2100
ARI6-150NS	15,0	13	24	440	440	930	110	separate	100	2100
ARI6-180NS	18,0	18	30	440	440	930	110	separate	125	2100

Separate Control

HEATER MODEL	kW	SAUNA ROOM		SIZE OF HEATER			STONES (kg)	CONTROL	MINIMUM SAFETY DISTANCES	
		MIN (m³)	MAX	WIDTH	DEPTH (mm)	HEIGHT			A	B
ARI3-45NS-WL	4,5	3	6	415	*250	1030	65	separate	100	1900
ARI3-60NS-WL	6,0	5	8	415	*250	1030	65	separate	100	1900
ARI3-75NS-WL	7,5	7	12	415	*250	1030	65	separate	100	1900
ARI3-90NS-WL	9,0	8	14	415	*250	1030	65	separate	100	1900

Ni2 Version

HEATER MODEL	kW	SAUNA ROOM		SIZE OF HEATER			STONES (kg)	CONTROL	MINIMUM SAFETY DISTANCES	
		MIN (m³)	MAX	WIDTH	DEPTH (mm)	HEIGHT			A	B
ARI3-45Ni2	4,5	3	6	300	300	930	60	Saunova	100	1900
ARI3-60Ni2	6,0	5	8	300	300	930	60	Saunova	100	1900
ARI3-75Ni2	7,5	7	12	300	300	930	60	Saunova	100	1900
ARI3-90Ni2	9,0	8	14	300	300	930	60	Saunova	100	1900

Ni2 Version

HEATER MODEL	kW	SAUNA ROOM		SIZE OF HEATER			STONES (kg)	CONTROL	MINIMUM SAFETY DISTANCES	
		MIN (m³)	MAX	WIDTH	DEPTH (mm)	HEIGHT			A	B
ARI3-45Ni2-WL	4,5	3	6	415	*250	1030	65	Saunova	100	1900
ARI3-60Ni2-WL	6,0	5	8	415	*250	1030	65	Saunova	100	1900
ARI3-75Ni2-WL	7,5	7	12	415	*250	1030	65	Saunova	100	1900
ARI3-90Ni2-WL	9,0	8	14	415	*250	1030	65	Saunova	100	1900

\*Depth when installed to the wall.

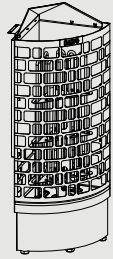

Aries CORNER

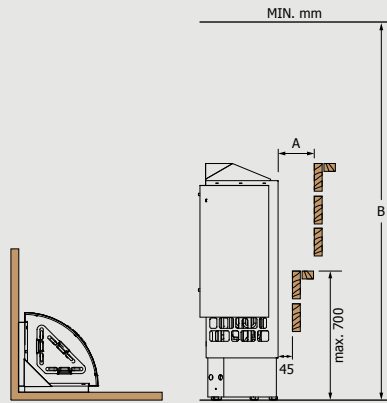

Minimum Safety Distances

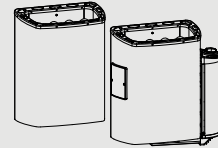

Mini

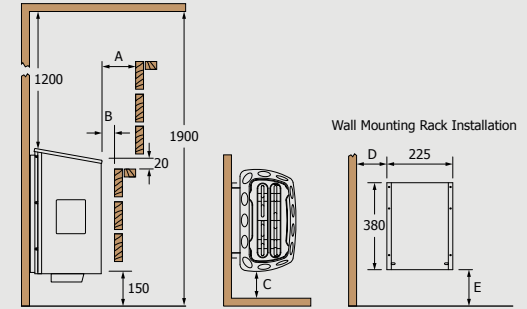

Minimum Safety Distances

Built-in Control

HEATER MODEL	kW	SAUNA ROOM		SIZE OF HEATER			STONES (KG)	CONTROL	MINIMUM SAFETY DISTANCES	
		MIN (m³)	MAX	WIDTH	DEPTH (mm)	HEIGHT			A	B
ARI3-45NB-CNR	4,5	3	6	335	*335	1000	65	built-in	100	1900
ARI3-60NB-CNR	6,0	5	8	335	*335	1000	65	built-in	100	1900
ARI3-75NB-CNR	7,5	7	12	335	*335	1000	65	built-in	100	1900
ARI3-90NB-CNR	9,0	8	14	335	*335	1000	65	built-in	100	1900

Built-in Control

HEATER MODEL	kW	SAUNA ROOM		SIZE OF HEATER			STONES (KG)	CONTROL	MINIMUM SAFETY DISTANCES				
		MIN (m³)	MAX	WIDTH	DEPTH (mm)	HEIGHT			A	B	C	D	E
MN-23NB	2,3	1,3	2,5	435	*215	**455	11	built-in	100	20	100	140	155
MN-30NB	3,0	2	4	435	*215	**455	11	built-in	100	20	100	140	155
MN-36NB	3,6	3	6	435	*215	**455	11	built-in	100	20	100	140	155

Separate Control

HEATER MODEL	kW	SAUNA ROOM		SIZE OF HEATER			STONES (KG)	CONTROL	MINIMUM SAFETY DISTANCES	
		MIN (m³)	MAX	WIDTH	DEPTH (mm)	HEIGHT			A	B
ARI3-45NS-CNR	4,5	3	6	335	*335	1000	65	separate	100	1900
ARI3-60NS-CNR	6,0	5	8	335	*335	1000	65	separate	100	1900
ARI3-75NS-CNR	7,5	7	12	335	*335	1000	65	separate	100	1900
ARI3-90NS-CNR	9,0	8	14	335	*335	1000	65	separate	100	1900

Separate Control

HEATER MODEL	kW	SAUNA ROOM		SIZE OF HEATER			STONES (KG)	CONTROL	MINIMUM SAFETY DISTANCES				
		MIN (m³)	MAX	WIDTH	DEPTH (mm)	HEIGHT			A	B	C	D	E
MN-23NS	2,3	1,3	2,5	330	*215	**455	11	separate	50	20	40	90	155
MN-30NS	3,0	2	4	330	*215	**455	11	separate	60	20	50	90	155
MN-36NS	3,6	3	6	330	*215	**455	11	separate	60	20	50	90	155

Ni2 Version

HEATER MODEL	kW	SAUNA ROOM		SIZE OF HEATER			STONES (KG)	CONTROL	MINIMUM SAFETY DISTANCES	
		MIN (m³)	MAX	WIDTH	DEPTH (mm)	HEIGHT			A	B
ARI3-45Ni2-CNR	4,5	3	6	335	*335	1000	65	Saunova	100	1900
ARI3-60Ni2-CNR	6,0	5	8	335	*335	1000	65	Saunova	100	1900
ARI3-75Ni2-CNR	7,5	7	12	335	*335	1000	65	Saunova	100	1900
ARI3-90Ni2-CNR	9,0	8	14	335	*335	1000	65	Saunova	100	1900

Combi Control

HEATER MODEL	kW	SAUNA ROOM		SIZE OF HEATER			STONES (KG)	CONTROL
		MIN (m³)	MAX	WIDTH	DEPTH (mm)	HEIGHT		
MNC-23NS	2,3	2	4	330	*260	500	8-10,5	separate
MNC-23NSF	2,3	2	4	330	*260	500	8-10,5	separate
MNC-30NS	3,0	2	4	330	*260	500	8-10,5	separate
MNC-30NSF	3,0	2	4	330	*260	500	8-10,5	separate
MNC-36NS	3,6	3	6	330	*260	500	8-10,5	separate
MNC-36NSF	3,6	3	6	330	*260	500	8-10,5	separate

\*Depth when installed to the wall.

\*Depth when installed to the wall.

\*\*Reflector not included.

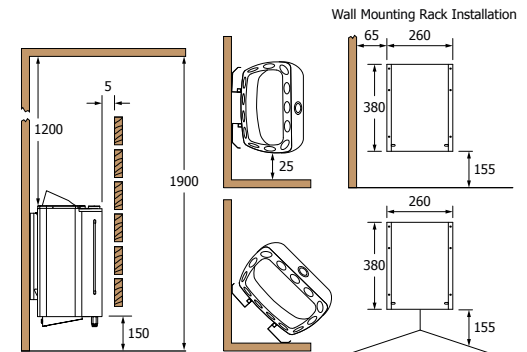

Minimum Safety Distances for Mini Combi

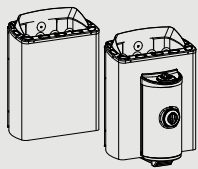

Mini X

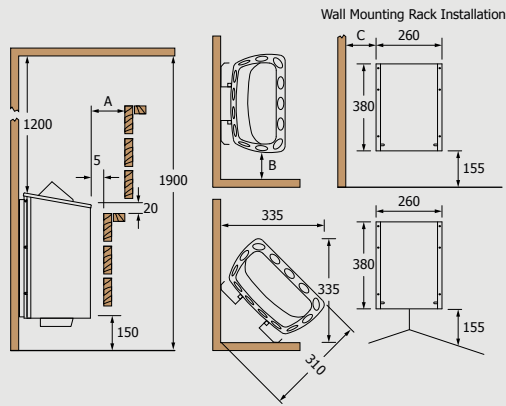

Minimum Safety Distances

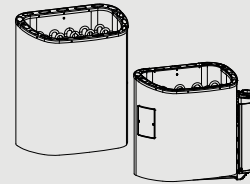

Scandia

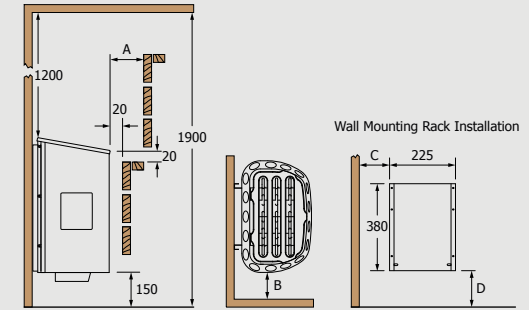

Minimum Safety Distances

Built-in Control

HEATER MODEL	kW	SAUNA ROOM		SIZE OF HEATER			STONES (kg)	CONTROL	MINIMUM SAFETY DISTANCES		
		MIN (m³)	MAX	WIDTH	DEPTH	HEIGHT			A	B	C
MX-23NB	2,3	1,3	2,5	330	*310/435	485	11	built-in	30	20	60
MX-30NB	3,0	2	4	330	*310/435	485	11	built-in	35	25	65
MX-36NB	3,6	3	6	330	*310/435	485	11	built-in	40	25	65

Separate Control

HEATER MODEL	kW	SAUNA ROOM		SIZE OF HEATER			STONES (kg)	CONTROL	MINIMUM SAFETY DISTANCES		
		MIN (m³)	MAX	WIDTH	DEPTH	HEIGHT			A	B	C
MX-23NS	2,3	1,3	2,5	330	*200/320	495	11	separate	30	20	60
MX-30NS	3,0	2	4	330	*200/320	495	11	separate	35	25	65
MX-36NS	3,6	3	6	330	*200/320	495	11	separate	40	25	65

\*Wall mounted/corner mounted.

Built-in Control

HEATER MODEL	kW	SAUNA ROOM		SIZE OF HEATER			STONES (kg)	CONTROL	MINIMUM SAFETY DISTANCES			
		MIN (m³)	MAX	WIDTH	DEPTH	HEIGHT			A	B	C	D
SCA-45NB	4,5	3	6	515	*290	**455	22	built-in	100	100	185	155
SCA-60NB	6,0	5	8	515	*290	**455	22	built-in	100	100	185	155
SCA-80NB	8,0	7	13	515	*290	**525	22	built-in	100	100	185	235
SCA-90NB	9,0	8	14	515	*290	**525	22	built-in	100	100	185	235

Separate Control

HEATER MODEL	kW	SAUNA ROOM		SIZE OF HEATER			STONES (kg)	CONTROL	MINIMUM SAFETY DISTANCES			
		MIN (m³)	MAX	WIDTH	DEPTH	HEIGHT			A	B	C	D
SCA-45NS	4,5	3	6	410	*290	**455	22	separate	100	100	135	155
SCA-60NS	6,0	5	8	410	*290	**455	22	separate	100	100	135	155
SCA-80NS	8,0	7	13	410	*290	**525	22	separate	100	100	135	235
SCA-90NS	9,0	8	14	410	*290	**525	22	separate	100	100	135	235

Combi Control

HEATER MODEL	kW	SAUNA ROOM		SIZE OF HEATER			STONES (kg)	CONTROL	MINIMUM SAFETY DISTANCES			
		MIN (m³)	MAX	WIDTH	DEPTH	HEIGHT			A	B	C	D
SCAC-60NS	6,0	5	9	410	*365	595	18-22	separate	5	50	135	1900
SCAC-80NS	8,0	7	13	410	*365	595	18-22	separate	5	50	135	1900
SCAC-90NS	9,0	8	14	410	*365	595	18-22	separate	5	50	135	1900

\*Depth when installed to the wall.

\*\*Reflector not included.

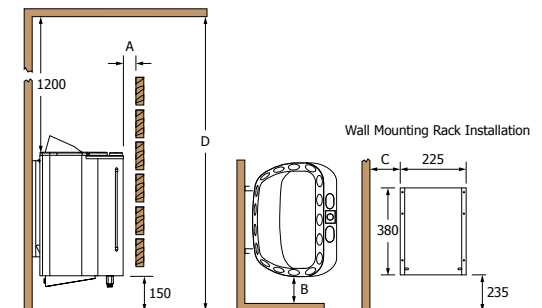

Minimum Safety Distances for Scandia Combi

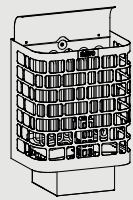

Krios

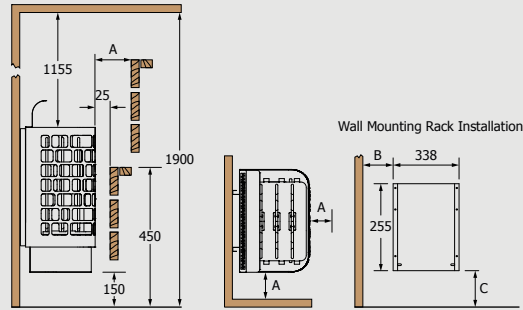

Minimum Safety Distances

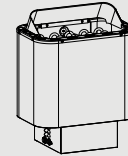

Nordex

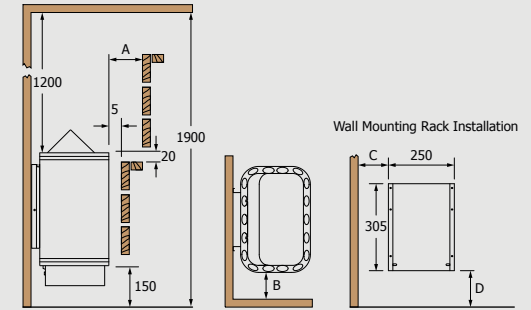

Minimum Safety Distances

Built-in Control

HEATER MODEL	kW	SAUNA ROOM (m³)		SIZE OF HEATER (mm)			STONES (KG)	CONTROL	MINIMUM SAFETY DISTANCES		
		MIN	MAX	WIDTH	DEPTH	HEIGHT			A	B	C
KRI-45NB	4,5	3	6	390	*290	**580	40	Built-in	50	75	320
KRI-60NB	6,0	5	9	390	*290	**580	40	Built-in	80	105	320
KRI-80NB	8,0	7	13	390	*290	**650	50	Built-in	100	125	390
KRI-90NB	9,0	8	14	390	*290	**650	50	Built-in	100	125	390

Separate Control

HEATER MODEL	kW	SAUNA ROOM (m³)		SIZE OF HEATER (mm)			STONES (KG)	CONTROL	MINIMUM SAFETY DISTANCES		
		MIN	MAX	WIDTH	DEPTH	HEIGHT			A	B	C
KRI-45NS	4,5	3	6	390	*290	**580	40	Innova	50	75	320
KRI-60NS	6,0	5	9	390	*290	**580	40	Innova	80	105	320
KRI-80NS	8,0	7	13	390	*290	**650	50	Innova	100	125	390
KRI-90NS	9,0	8	14	390	*290	**650	50	Innova	100	125	390

Ni2 Version

HEATER MODEL	kW	SAUNA ROOM (m³)		SIZE OF HEATER (mm)			STONES (KG)	CONTROL	MINIMUM SAFETY DISTANCES		
		MIN	MAX	WIDTH	DEPTH	HEIGHT			A	B	C
KRI-45Ni2	4,5	3	6	390	*290	**600	40	Saunova 2.0	50	75	345
KRI-60Ni2	6,0	5	9	390	*290	**600	40	Saunova 2.0	80	105	345
KRI-80Ni2	8,0	7	13	390	*290	**670	50	Saunova 2.0	100	125	415
KRI-90Ni2	9,0	8	14	390	*290	**670	50	Saunova 2.0	100	125	415

\*Depth when installed to the wall.  
\*\*Height with reflector.

Built-in | Separate Control

HEATER MODEL	kW	SAUNA ROOM (m³)		SIZE OF HEATER (mm)			STONES (KG)	CONTROL	MINIMUM SAFETY DISTANCES			
		MIN	MAX	WIDTH	DEPTH	HEIGHT			A	B	C	D
NR-45NB NS	4,5	3	6	410	*300	**510	22	built-in separate	50	50	130	270
NR-60NB NS	6,0	5	9	410	*300	**510	22	built-in separate	50	50	130	270
NR-80NB NS	8,0	7	13	410	*300	**585	22	built-in separate	80	80	160	330
NR-90NB NS	9,0	8	14	410	*300	**585	22	built-in separate	80	80	160	330

Ni2 Version

HEATER MODEL	kW	SAUNA ROOM (m³)		SIZE OF HEATER (mm)			STONES (KG)	CONTROL	MINIMUM SAFETY DISTANCES			
		MIN	MAX	WIDTH	DEPTH	HEIGHT			A	B	C	D
NR-45Ni2	4,5	3	6	410	*300	**510	22	Saunova 2.0	50	50	130	270
NR-60Ni2	6,0	5	9	410	*300	**510	22	Saunova 2.0	50	50	130	270
NR-80Ni2	8,0	7	13	410	*300	**585	22	Saunova 2.0	80	80	160	330
NR-90Ni2	9,0	8	14	410	*300	**585	22	Saunova 2.0	80	80	160	330

Combi Control

HEATER MODEL	kW	SAUNA ROOM (m³)		SIZE OF HEATER (mm)			STONES (KG)	CONTROL
		MIN	MAX	WIDTH	DEPTH	HEIGHT		
NRC-60NS	6,0	5	9	410	*365	**580	22	Innova
NRC-80NS	8,0	7	13	410	*365	**580	22	Innova
NRC-90NS	9,0	8	14	410	*365	**580	22	Innova

\*Depth when installed to the wall.  
\*\*Height with reflector.

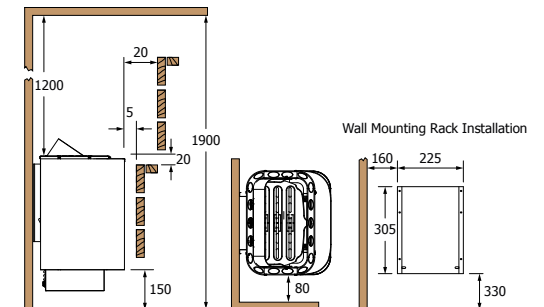

Minimum Safety Distances for Nordex Combi

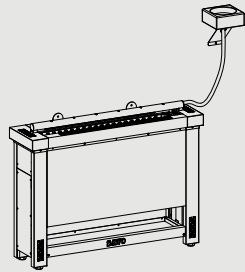

Helius

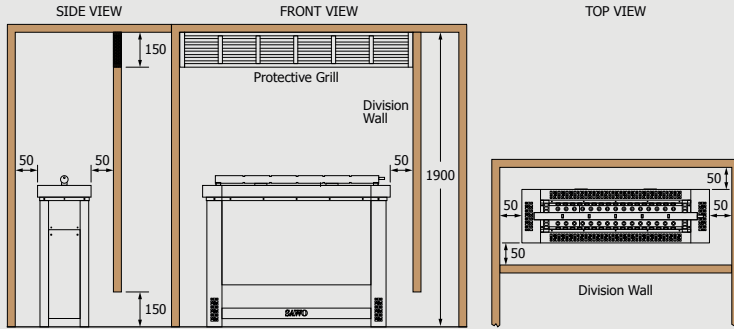

Minimum Safety Distances (Recess Wall)

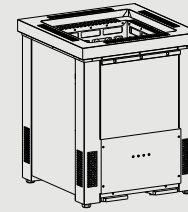

Taurus

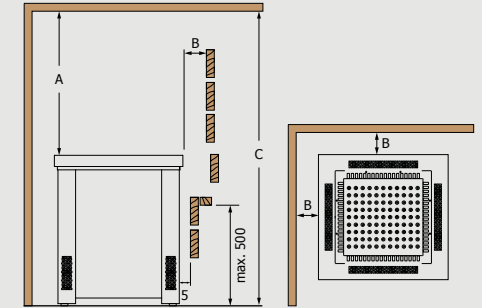

Minimum Safety Distances

Separate Control

HEATER MODEL	kW	SAUNA ROOM		SIZE OF HEATER			STONES (kg)	CONTROL
		MIN (m³)	MAX (m³)	WIDTH (mm)	DEPTH (mm)	HEIGHT (mm)		
HES-45NS	4,5	3	6	860	230	655	19	separate
HES-60NS	6,0	5	8	860	230	655	19	separate
HES-75NS	7,5	7	12	860	230	655	19	separate
HES-90NS	9,0	8	14	860	230	655	19	separate

Taurus

HEATER MODEL	kW	SAUNA ROOM		SIZE OF HEATER			STONES (kg)	CONTROL	MINIMUM SAFETY DISTANCES		
		MIN (m³)	MAX (m³)	WIDTH (mm)	DEPTH (mm)	HEIGHT (mm)			A	B	C
TAU-90NS	9,0	8	14	555	555	685	45	separate	1210	5/*50	1900
TAU-105NS	10,5	9	15	555	555	685	45	separate	1210	5/*50	1900
TAU-120NS	12,0	10	18	555	555	685	45	separate	1410	5/*50	2100
TAU-150NS	15,0	14	25	705	555	685	65	separate	1410	5/*50	2100
TAU-180NS	18,0	18	30	705	555	685	65	separate	1410	5/*50	2100
TAU-180NS-V12	18,0	18	30	955	555	685	90	separate	1410	5/*50	2100
TAU-210NS-V12	21,0	22	35	955	555	685	90	separate	1410	5/*50	2100
TAU-240NS-V12	24,0	24	40	955	555	685	90	separate	1410	5/*50	2100

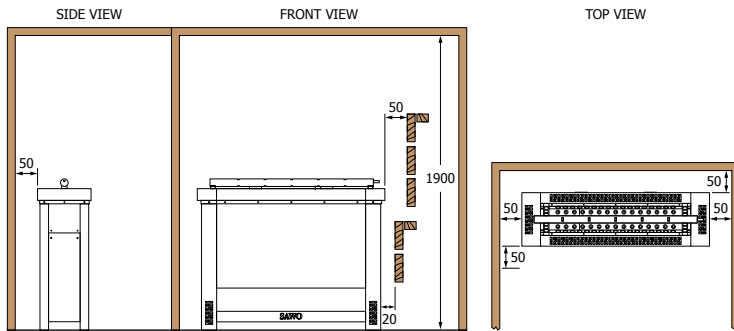

Minimum Safety Distances (Normal Installation)

Taurus G-Model

HEATER MODEL	kW	SAUNA ROOM		SIZE OF HEATER			STONES (kg)	CONTROL	MINIMUM SAFETY DISTANCES		
		MIN (m³)	MAX (m³)	WIDTH (mm)	DEPTH (mm)	HEIGHT (mm)			A	B	C
TAU-90NS-G	9,0	8	14	555	555	685	50	separate	1210	5/*50	1900
TAU-105NS-G	10,5	9	15	555	555	685	50	separate	1210	5/*50	1900
TAU-120NS-G	12,0	10	18	555	555	685	50	separate	1410	5/*50	2100
TAU-150NS-G	15,0	14	25	705	555	685	75	separate	1410	5/*50	2100
TAU-180NS-G	18,0	18	30	705	555	685	75	separate	1410	5/*50	2100
TAU-180NS-V12-G	18,0	18	30	955	555	685	100	separate	1410	5/*50	2100
TAU-210NS-V12-G	21,0	22	35	955	555	685	100	separate	1410	5/*50	2100
TAU-240NS-V12-G	24,0	24	40	955	555	685	100	separate	1410	5/*50	2100

\*For commercial use.

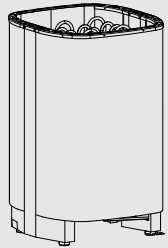

Savonia

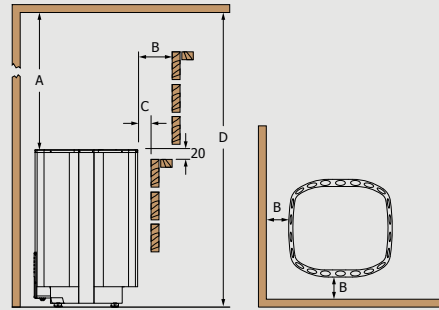

Minimum Safety Distances

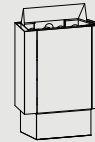

Nordex MINI

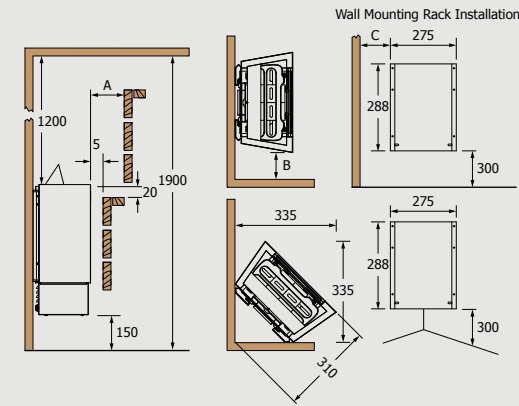

Minimum Safety Distances

Built-in Control

HEATER MODEL	kW	SAUNA ROOM (m³)		SIZE OF HEATER (mm)			STONES (kg)	CONTROL	MINIMUM SAFETY DISTANCES			
		MIN	MAX	WIDTH	DEPTH	HEIGHT			A	B	C	D
SAV-90NB	9,0	8	14	450	505	655	50	built-in	1200	110	50	1900

Separate Control

HEATER MODEL	kW	SAUNA ROOM (m³)		SIZE OF HEATER (mm)			STONES (kg)	CONTROL	MINIMUM SAFETY DISTANCES			
		MIN	MAX	WIDTH	DEPTH	HEIGHT			A	B	C	D
SAV-90NS	9,0	8	14	440	420	655	50	separate	1200	110	50	1900
SAV-105NS	10,5	9	15	440	420	655	50	separate	1200	120	60	1900
SAV-120NS	12,0	10	18	440	420	655	50	separate	1400	130	70	2100
SAV-150NS	15,0	13	23	590	420	655	75	separate	1400	160	100	2100
SAV-180NS	18,0	17	29	590	420	655	75	separate	1400	160	100	2100
SAV-180NS-V12	18,0	18	30	740	420	655	100	separate	1400	160	100	2100
SAV-210NS-V12	21,0	22	35	740	420	655	100	separate	1400	160	100	2100
SAV-240NS-V12	24,0	26	42	740	420	655	100	separate	1400	160	100	2100

Combi Control

HEATER MODEL	kW	SAUNA ROOM (m³)		SIZE OF HEATER (mm)			STONES (kg)	CONTROL	MINIMUM SAFETY DISTANCES			
		MIN	MAX	WIDTH	DEPTH	HEIGHT			A	B	C	D
SAVC-90NS	9,0	8	14	510	420	655	50	separate	1200	110	50	1900
SAVC-105NS	10,5	9	15	510	420	655	50	separate	1200	120	60	1900
SAVC-120NS	12,0	10	18	510	420	655	50	separate	1400	130	70	2100
SAVC-150NS	15,0	13	23	715	420	655	75	separate	1400	160	100	2100
SAVC-180NS	18,0	17	29	715	420	655	75	separate	1400	160	100	2100

Built-in | Separate Control

HEATER MODEL	kW	SAUNA ROOM (m³)		SIZE OF HEATER (mm)			STONES (kg)	CONTROL	MINIMUM SAFETY DISTANCES		
		MIN	MAX	WIDTH	DEPTH	HEIGHT			A	B	C
NRMN-23NB NS	2,3	1,3	2,5	340	*200	500	11	built-in separate	30 50	20 30	60 85
NRMN-30NB NS	3,0	2	4	340	*200	500	11	built-in separate	35 50	25 30	65 85
NRMN-36NB NS	3,6	3	6	340	*200	500	11	built-in separate	40 50	25 30	65 85

Ni2 Version

HEATER MODEL	kW	SAUNA ROOM (m³)		SIZE OF HEATER (mm)			STONES (kg)	CONTROL	MINIMUM SAFETY DISTANCES		
		MIN	MAX	WIDTH	DEPTH	HEIGHT			A	B	C
NRMN-23Ni2	2,3	1,3	2,5	340	*200	500	11	Saunova	50	30	85
NRMN-30Ni2	3,0	2	4	340	*200	500	11	Saunova	50	30	85
NRMN-36Ni2	3,6	3	6	340	*200	500	11	Saunova	50	30	85

Combi Control

HEATER MODEL	kW	SAUNA ROOM (m³)		SIZE OF HEATER (mm)			STONES (kg)	CONTROL
		MIN	MAX	WIDTH	DEPTH	HEIGHT		
NRMNC-30NS Ni2	3,0	2	4	340	*240	500	11	separate Saunova
NRMNC-36NS Ni2	3,6	3	6	340	*240	500	11	separate Saunova

\*Depth when installed to the wall.

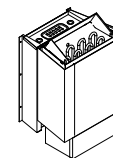

Nordex Mini Combi

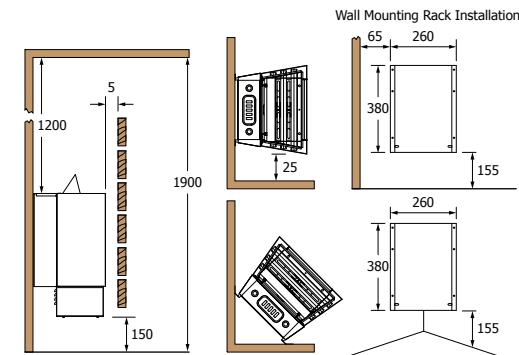

Minimum Safety Distances for Nordex Mini Combi

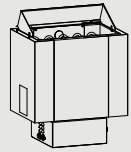

Nordex Plus

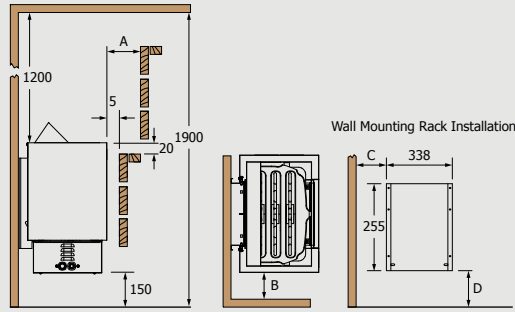

Minimum Safety Distances

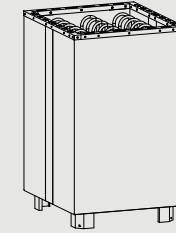

Nordex FLOOR

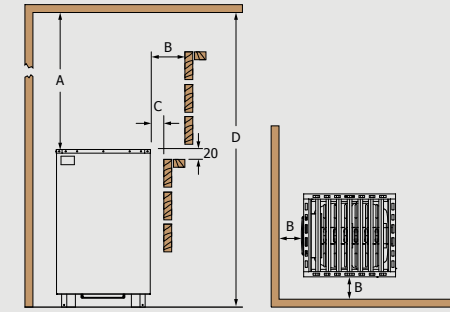

Minimum Safety Distances

Built-in | Separate Control

HEATER MODEL	kW	SAUNA ROOM (m <sup>2</sup> )		SIZE OF HEATER (mm)			STONES (kg)	CONTROL	MINIMUM SAFETY DISTANCES			
		MIN	MAX	WIDTH	DEPTH	HEIGHT			A	B	C	D
NRX-45NB NS	4,5	3	6	400	*295	515	18	built-in separate	50	50	80	320
NRX-60NB NS	6,0	5	8	400	*295	515	18	built-in separate	50	50	80	320
NRX-80NB NS	8,0	7	13	400	*295	590	22	built-in separate	80	80	110	395
NRX-90NB NS	9,0	8	14	400	*295	590	22	built-in separate	80	80	110	395

Ni2 Version

HEATER MODEL	kW	SAUNA ROOM (m <sup>2</sup> )		SIZE OF HEATER (mm)			STONES (kg)	CONTROL	MINIMUM SAFETY DISTANCES			
		MIN	MAX	WIDTH	DEPTH	HEIGHT			A	B	C	D
NRX-45Ni2	4,5	3	6	400	*295	515	18	Saunova	50	50	80	320
NRX-60Ni2	6,0	5	8	400	*295	515	18	Saunova	50	50	80	320
NRX-80Ni2	8,0	7	13	400	*295	590	22	Saunova	80	80	110	395
NRX-90Ni2	9,0	8	14	400	*295	590	22	Saunova	80	80	110	395

Combi Control

HEATER MODEL	kW	SAUNA ROOM (m <sup>2</sup> )		SIZE OF HEATER (mm)			STONES (kg)	CONTROL	MINIMUM SAFETY DISTANCES			
		MIN	MAX	WIDTH	DEPTH	HEIGHT			A	B	C	D
NRC-60NS	6,0	5	8	400	*335	515	18	separate	5	50	135	1900
NRC-80NS	8,0	7	13	400	*335	590	22	separate	5	50	135	1900
NRC-90NS	9,0	8	14	400	*335	590	22	separate	5	50	135	1900

\*Depth when installed to the wall.

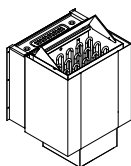

Nordex Plus Combi

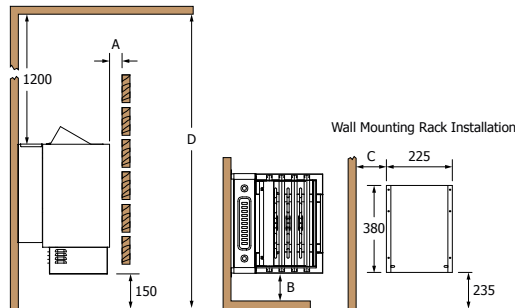

Minimum Safety Distances for Nordex Combi

Separate Control

HEATER MODEL	kW	SAUNA ROOM (m <sup>2</sup> )		SIZE OF HEATER (mm)			STONES (kg)	CONTROL	MINIMUM SAFETY DISTANCES			
		MIN	MAX	WIDTH	DEPTH	HEIGHT			A	B	C	D
NRFS-90NS	9,0	8	14	450	400	670	50	separate	1200	120	50	1900
NRFS-105NS	10,5	9	15	450	400	670	50	separate	1200	120	60	1900
NRFS-120NS	12,0	10	18	450	400	670	50	separate	1400	130	70	2100
NRFS-150NS	15,0	13	23	595	400	670	75	separate	1400	160	100	2100
NRFS-180NS	18,0	17	29	595	400	670	75	separate	1400	160	100	2100
NRFS-180NS-V12	18,0	18	30	740	400	670	100	separate	1400	160	100	2100
NRFS-210NS-V12	21,0	22	35	740	400	670	100	separate	1400	160	100	2100
NRFS-240NS-V12	24,0	26	42	740	400	670	100	separate	1400	160	100	2100



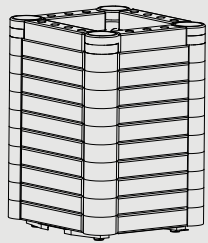

Nimbus

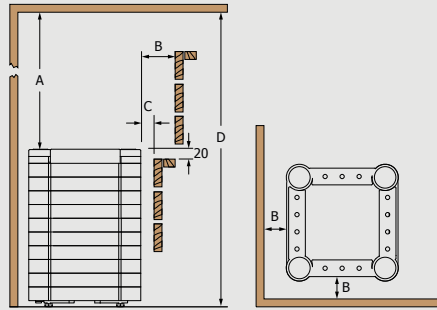

Minimum Safety Distances

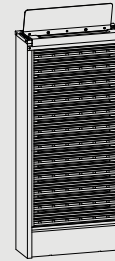

Cirrus

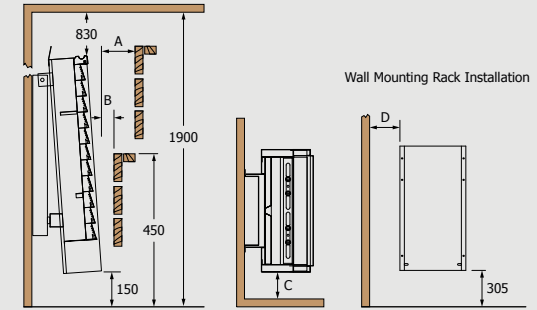

Minimum Safety Distances

Separate Control

HEATER MODEL	kW	SAUNA ROOM (m³)		SIZE OF HEATER (mm)			STONES (kg)	SOAPSTONES (kg)	CONTROL	MINIMUM SAFETY DISTANCES (mm)			
		MIN	MAX	WIDTH	DEPTH	HEIGHT				A	B	C	D
NIM-90NS	9,0	8	14	520	470	690	50	80	separate	1200	110	50	1900
NIM-105NS	10,5	9	15	520	470	690	50	80	separate	1200	120	60	1900
NIM-120NS	12,0	10	18	520	470	690	50	80	separate	1400	130	70	2100
NIM-150NS	15,0	13	23	660	470	690	75	100	separate	1400	160	100	2100
NIM-180NS	18,0	17	29	660	470	690	75	100	separate	1400	160	100	2100
NIM-180NS-V12	18,0	18	30	820	470	690	100	120	separate	1400	160	100	2100
NIM-210NS-V12	21,0	22	35	820	470	690	100	120	separate	1400	160	100	2100
NIM-240NS-V12	24,0	26	42	820	470	690	100	120	separate	1400	160	100	2100

Combi Control

HEATER MODEL	kW	SAUNA ROOM (m³)		SIZE OF HEATER (mm)			STONES (kg)	SOAPSTONES (kg)	CONTROL	MINIMUM SAFETY DISTANCES (mm)			
		MIN	MAX	WIDTH	DEPTH	HEIGHT				A	B	C	D
NIMC-90NS	9,0	8	14	575	470	690	50	90	separate	1200	50	30	1900
NIMC-105NS	10,5	9	15	575	470	690	50	90	separate	1200	50	30	1900
NIMC-120NS	12,0	10	18	575	470	690	50	90	separate	1400	130	70	2100
NIMC-150NS	15,0	13	23	775	470	690	75	120	separate	1400	160	100	2100
NIMC-180NS	18,0	17	29	775	470	690	75	120	separate	1400	160	100	2100

Built-in Control

HEATER MODEL	kW	SAUNA ROOM (m³)		SIZE OF HEATER (mm)			STONES (kg)	SOAPSTONES (kg)	CONTROL	MINIMUM SAFETY DISTANCES (mm)			
		MIN	MAX	WIDTH	DEPTH	HEIGHT				A	B	C	D
CIR2-30NB	3,0	2	4	400	*205	965	6	23	built-in	200	100	75	150
CIR2-40NB	4,0	3	6	400	*205	965	6	23	built-in	200	100	75	150
CIR2-50NB	5,0	4	8	400	*205	965	6	23	built-in	275	100	75	150
CIR2-60NB	6,0	5	8	400	*205	965	6	23	built-in	300	100	100	175
CIR3-45NB	4,5	3	6	565	*205	965	10	34	built-in	250	100	75	230
CIR3-60NB	6,0	5	9	565	*205	965	10	34	built-in	300	100	100	255
CIR3-75NB	7,5	7	12	565	*205	965	10	34	built-in	350	125	100	255
CIR3-90NB	9,0	8	14	565	*205	965	10	34	built-in	400	125	125	280

Separate Control

HEATER MODEL	kW	SAUNA ROOM (m³)		SIZE OF HEATER (mm)			STONES (kg)	SOAPSTONES (kg)	CONTROL	MINIMUM SAFETY DISTANCES (mm)			
		MIN	MAX	WIDTH	DEPTH	HEIGHT				A	B	C	D
CIR2-30NS	3,0	2	4	400	*205	965	6	23	separate	250	100	75	150
CIR2-40NS	4,0	3	6	400	*205	965	6	23	separate	250	100	75	150
CIR2-50NS	5,0	4	8	400	*205	965	6	23	separate	300	100	75	150
CIR2-60NS	6,0	5	8	400	*205	965	6	23	separate	350	100	100	175
CIR3-45NS	4,5	3	6	565	*205	965	10	34	separate	300	100	75	230
CIR3-60NS	6,0	5	9	565	*205	965	10	34	separate	350	100	100	255
CIR3-75NS	7,5	7	12	565	*205	965	10	34	separate	400	100	100	255
CIR3-90NS	9,0	8	14	565	*205	965	10	34	separate	450	100	125	280

\*Depth when installed to the wall.

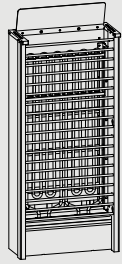

Cirrus ROCK

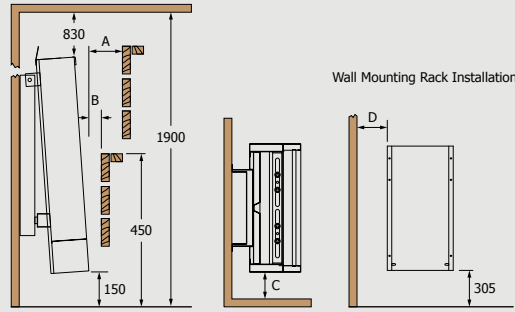

Minimum Safety Distances



Cumulus

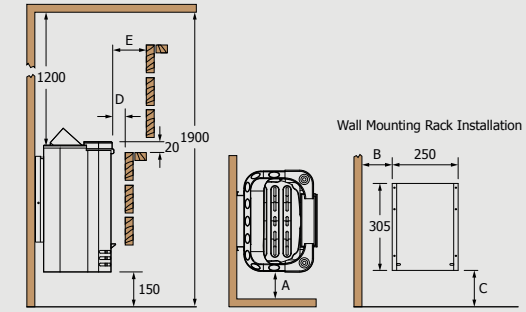

Minimum Safety Distances

Built-in Control

HEATER MODEL	kW	SAUNA ROOM (m <sup>2</sup> )		SIZE OF HEATER (mm)			STONES	SOAPSTONES (kg)	CONTROL	MINIMUM SAFETY DISTANCES			
		MIN	MAX	WIDTH	DEPTH	HEIGHT				A	B	C	D
CRR2-30NB	3,0	2	4	400	*235	965	40	-	built-in	200	100	75	150
CRR2-40NB	4,0	3	6	400	*235	965	40	-	built-in	200	100	75	150
CRR2-50NB	5,0	4	8	400	*235	965	40	-	built-in	200	100	75	150
CRR2-60NB	6,0	5	8	400	*235	965	40	-	built-in	225	100	100	175
CRR3-45NB	4,5	3	6	565	*235	965	65	-	built-in	200	100	75	230
CRR3-60NB	6,0	5	9	565	*235	965	65	-	built-in	225	100	100	255
CRR3-75NB	7,5	7	12	565	*235	965	65	-	built-in	250	125	100	255
CRR3-90NB	9,0	8	14	565	*235	965	65	-	built-in	300	125	125	280

Separate Control

HEATER MODEL	kW	SAUNA ROOM (m <sup>2</sup> )		SIZE OF HEATER (mm)			STONES	SOAPSTONES (kg)	CONTROL	MINIMUM SAFETY DISTANCES			
		MIN	MAX	WIDTH	DEPTH	HEIGHT				A	B	C	D
CRR2-30NS	3,0	2	4	400	*235	965	40	-	separate	200	100	75	150
CRR2-40NS	4,0	3	6	400	*235	965	40	-	separate	200	100	75	150
CRR2-50NS	5,0	4	8	400	*235	965	40	-	separate	225	100	75	150
CRR2-60NS	6,0	5	8	400	*235	965	40	-	separate	250	100	100	175
CRR3-45NS	4,5	3	6	565	*235	965	65	-	separate	200	100	75	230
CRR3-60NS	6,0	5	9	565	*235	965	65	-	separate	250	100	100	255
CRR3-75NS	7,5	7	12	565	*235	965	65	-	separate	300	100	100	255
CRR3-90NS	9,0	8	14	565	*235	965	65	-	separate	350	100	125	280

\*Depth when installed to the wall.

Built-in Control

HEATER MODEL	kW	SAUNA ROOM (m <sup>2</sup> )		SIZE OF HEATER (mm)			STONES	SOAPSTONES (kg)	CONTROL	MINIMUM SAFETY DISTANCES				
		MIN	MAX	WIDTH	DEPTH	HEIGHT				A	B	C	D	E
CML-45NB	4,5	3	6	420	*325	500	18	10	built-in	50	130	245	20	50
CML-60NB	6,0	5	8	420	*325	500	18	10	built-in	50	130	245	20	50
CML-80NB	8,0	7	13	420	*325	590	22	10	built-in	60	140	330	30	60
CML-90NB	9,0	8	14	420	*325	590	22	10	built-in	60	140	330	30	60

Separate Control

HEATER MODEL	kW	SAUNA ROOM (m <sup>2</sup> )		SIZE OF HEATER (mm)			STONES	SOAPSTONES (kg)	CONTROL	MINIMUM SAFETY DISTANCES				
		MIN	MAX	WIDTH	DEPTH	HEIGHT				A	B	C	D	E
CML-45NS	4,5	3	6	420	*325	500	18	10	separate	50	130	245	20	50
CML-60NS	6,0	5	8	420	*325	500	18	10	separate	50	130	245	20	50
CML-80NS	8,0	7	13	420	*325	590	22	10	separate	60	140	330	30	60
CML-90NS	9,0	8	14	420	*325	590	22	10	separate	60	140	330	30	60

Ni2 Version

HEATER MODEL	kW	SAUNA ROOM (m <sup>2</sup> )		SIZE OF HEATER (mm)			STONES	SOAPSTONES (kg)	CONTROL	MINIMUM SAFETY DISTANCES				
		MIN	MAX	WIDTH	DEPTH	HEIGHT				A	B	C	D	E
CML-45Ni2	4,5	3	6	420	*325	500	18	10	Saunova	50	130	245	20	50
CML-60Ni2	6,0	5	8	420	*325	500	18	10	Saunova	50	130	245	20	50
CML-80Ni2	8,0	7	13	420	*325	590	22	10	Saunova	60	140	330	30	60
CML-90Ni2	9,0	8	14	420	*325	590	22	10	Saunova	60	140	330	30	60

\*Depth when installed to the wall.

# HEATER Accessories

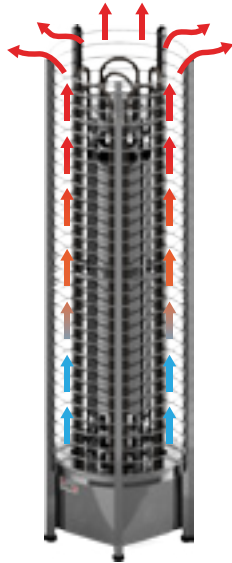

## Stone Spacer

With Stone Spacer

- » Heating up time is reduced which saves electricity
- » Extend life span of heating element
- » Improves air circulation
- » Hotter room temperature
- » 15-40% less stones

Without Stone Spacer

- » More stones means more steam
- » Softer steam
- » Milder room temperature
- » Massive amount of stones keep heat for a longer time
- » Energy efficient for commercial use where the heater is switched on for long periods of time



## Cozy Tank

- » Water storage that adds instant steam when heater is hot
- » Refillable water via top cover holes
- » Thick stainless metal
- » Carved soapstone top cover
- » Available in 2 designs
- » Scent pockets for sauna aroma

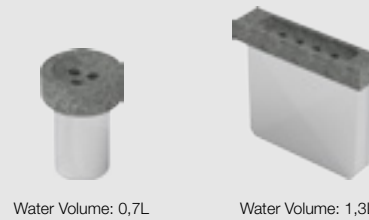

Water Volume: 0,7L

Water Volume: 1,3L

WATER VOLUME	HEATERS
0,7 Liter	Tower (Round, Wall, Corner), Aries (Round, Wall, Corner), Phoenix, Orion
1,3 Liter	Taurus, Mini, Mini X, Scandia, Savonia, Nordex Mini, Nordex, Nordex Floor, Nimbus, Cumulus

## Helius with Hood (Optional)

- » Keep a small space for wall divider to recess area so heater can go below the bench.



# CONTROLS

Pleasurable moments are just few clicks away.



# HEATER Controls

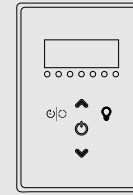

## Saunova 2.0 (SAU-UI-V2)

- » 5 buttons
- » 7 LED indicators
- » Stainless metal casing
- » Keypad lock
- » More than 9kW needs a Contactor
- » Temperature setting
- » Celsius or Fahrenheit temperature unit
- » Session Time limiter for 1h, 2h, 4h, 6h, 8h, 12h, 18h, 24h
- » Pre-run timer max 6h domestic use / 24h public use
- » Light Control
- » Steamer function with cabin drying (for Combi heaters only)
- » Fan switch (optional)
- » Heater safety switch (EN 60335-2-53) or door switch feature
- » Remote On feature for household automation



## Innova Classic 2.0 (INC-S-V2)

- » Thick stainless steel casing
- » LED digital display
- » Door sensor
- » Pre-run timer
- » Smart energy saving
- » Must be paired with Power Controller



## Innova Stainless Steel Touch (INT-S-SST)

- » Thick stainless steel casing
- » Animated buttons
- » LCD touch screen
- » Weekly timer
- » Optional light dimmer, fan and Combi functions
- » Remote controlling with potential free contact
- » Easy mode available
- » Key lock
- » Celsius or Fahrenheit temperature unit
- » Power consumption counter
- » Blackout memory
- » Additional bench temperature or humidity & temperature sensor can be installed
- » Must be paired with Power Controller

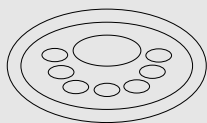

### Innova Classic (INC-S)

- » Oval shape interface with chrome plated ring
- » LED digital display
- » Door Sensor
- » Pre-run timer
- » Smart energy saving
- » Must be paired with Power Controller
- » Additional bench temperature or humidity & temperature sensor can be installed

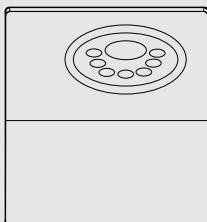

### Innova Classic Built-in (INC-B)

- » Integrated power controller and interface
- » Same feature as Innova Classic separate control
- » Additional bench temperature or humidity & temperature sensor can be installed



### Innova Power Controller (INP-C)

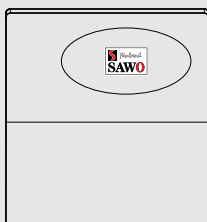

### Innova Contactor Unit (INP-S)

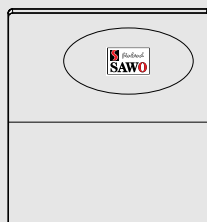

### Saunova Contactor Unit (SAU-PS-2)

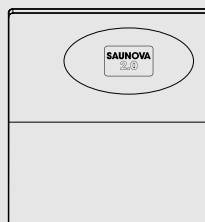

! A Contactor Unit is needed for more than 15kW power heater.

! Needed when heater is more than 9kW power.



# STEAM GENERATOR Controls

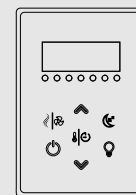

## STP Classic 2.0 (STP-INFACE-V2)

- » Thick stainless steel casing
- » LED digital display
- » Optional features: light dimmer, scent pump and fan
- » 7.5 meters RJ12 cable with connectors included



## STP Stainless Steel Touch (STP-INFACE-SST)

- » Thick stainless steel casing
- » Animated buttons
- » Compatible for automated household component
- » Emergency alarm provision
- » Standby mode to keep water warm until next session
- » Displays error code
- » Autodrain function
- » Key lock
- » Easy mode available
- » Date and time setup
- » Kilowatt usage counter
- » Decalcifying function
- » Heating Element fail detect
- » Blackout memory
- » Celsius or Fahrenheit temperature unit
- » Autolight
- » Autofan
- » LCD contrast adjustment
- » Optional scent pump, light dimmer and fan
- » Temperature sensor with wire
- » Optional interface holder
- » 7.5 meters RJ12 cable with connectors included

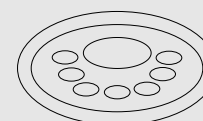

## STP Classic (STP-INFACE)

- » Oval shaped interface with chrome plated ring
- » LED digital display
- » Optional features: light dimmer, scent pump and fan
- » 7.5 meters RJ12 cable with connectors included

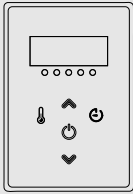

### STE Advance (STE-INFACE-V2)

- » Thick stainless steel casing
- » LED digital display
- » Optional features: light dimmer, scent pump and fan
- » 7.5 meters RJ12 cable with connectors included



### Saunova User Interface 1.0 (SAU-UI-1) STE Basic Control (STE-INFACE)

- » Thick stainless steel casing
- » Simple analog control
- » Illuminated power button
- » Min-max knob temperature control
- » 4 meters RJ11 cable (SAU-UI-1)
- » 7.5 meters RJ11 cable (STE-INFACE)
- » Temperature sensor with wire
- » Standby Mode





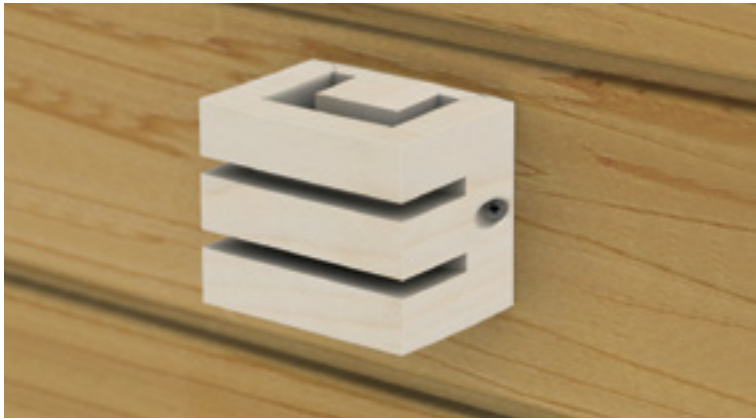

INCLUSIONS



RJ12 Cable



Temperature Sensor



Temperature Sensor with Fuse (INN-FTEMP)



OPTIONAL ITEMS

Interface Holders



» for Saunova 2.0, Classic 2.0, Stainless Steel Touch, Classic and Steam controls.

Temperature Sensors



Optional Second Temperature Sensor for Bench Area (INN-BTEMP)



Optional Humidity and Temperature Sensor for Bench Area (INN-HUM)



Holder for Power Controller and Contactor Unit

# STEAM Generators

Unwind stress with soothing clouds.





# STE Steam Generator

STE Steam generators are best for residential use. It has straight forward functions that is very easy to operate by switching on the control and adjusting the temperature knob. This steam generator is made from stainless steel. It can be installed that the steam outlet be facing left or right at any convenient position.

SAWO steam generators can be tapped up to 5 series connections to have maximum power output using only 1 control. Maximum power output is 75kW.

! For more technical information, see page 53.

## 2 Heating Elements



- » Steam output up to 6,7kg/hr
- » Can be installed in either side
- » Own pipe for overpressure valve
- » Steam head included
- » 3kW - 5kW power
- » STE Advance and STE Basic

## 3 Heating Elements



- » Steam output up to 7,5kg/hr
- » Can be installed in either side
- » Own pipe for overpressure valve
- » Steam head included
- » 4,5kW - 7,5kW power
- » STE Advance and STE Basic

## 6 Heating Elements



- » Steam output up to 20kg/hr
- » Can be installed in either side
- » Own pipe for overpressure valve
- » Steam head included
- » 9kW - 15kW power
- » STE Advance and STE Basic

# STN Steam Generator

A more robust and heavy-duty performer STN steam generators are the best choice for commercial use. It is bagged with several control features for a more desirable settings. Aroma, fan and dimmer lights are optional features. Demand button can be installed to release extra steam for 30 seconds. Troubleshooting becomes very handy as error codes are displayed on the controller screen.

STN steam generators are made from thick stainless steel to minimize corrosion. These steam generators can be installed in any favorable left or right orientation.

SAWO steam generators can be tapped up to 5 series connections to have maximum power output using only 1 control. Maximum power output is 75kW.



! For more technical information, see page 53.

## 2 Heating Elements



- » Steam output up to 6,7kg/hr
- » Can be installed in either side
- » Own pipe for overpressure valve
- » Auto drain
- » Steam head included
- » Cassette type heating element setup for easy maintenance
- » 3kW - 5kW power
- » 3/4" steam pipe
- » STP Classic, STP Classic 2.0 and STP Stainless Steel Touch

## 3 Heating Elements



- » Steam output up to 7,5kg/hr
- » Can be installed in either side
- » Own pipe for overpressure valve
- » Auto drain
- » Steam head included
- » Cassette type heating element setup for easy maintenance
- » 4,5kW - 7,5kW power
- » 3/4" steam pipe
- » STP Classic, STP Classic 2.0 and STP Stainless Steel Touch

## 6 Heating Elements



- » Steam output up to 20kg/hr
- » Can be installed in either side
- » Own pipe for overpressure valve
- » Auto drain
- » Steam head included
- » Cassette type heating element setup for easy maintenance
- » 9kW - 15kW power
- » 3/4" steam pipe
- » STP Classic, STP Classic 2.0 and STP Stainless Steel Touch

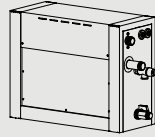

STE Steam Generator

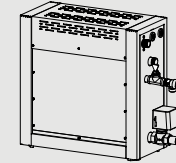

STN Steam Generator

2 Heating Elements

HEATER MODEL	kW	STEAM ROOM (m³)		SIZE OF HEATER (mm)			WEIGHT (kg)	CONTROL
		MIN	MAX	WIDTH	DEPTH	HEIGHT		
STE-30-1/2	3,0	3		555	205	465	16,5	STE Basic   Advance
STE-35-1/2	3,5	3,5		555	205	465	16,5	STE Basic   Advance
STE-40-1/2	4,0	4		555	205	465	16,5	STE Basic   Advance
STE-45-1/2	4,5	2	5	555	205	465	16,5	STE Basic   Advance
STE-50-1/2	5,0	2	6	555	205	465	16,5	STE Basic   Advance

3 Heating Elements

HEATER MODEL	kW	STEAM ROOM (m³)		SIZE OF HEATER (mm)			WEIGHT (kg)	CONTROL
		MIN	MAX	WIDTH	DEPTH	HEIGHT		
STE-45-C1/3	4,5	2	5	555	250	370	18	STE Basic   Advance
STE-60-C1/3	6,0	3	10	555	250	370	18	STE Basic   Advance
STE-75-C1/3	7,5	4	15	555	250	370	18	STE Basic   Advance

6 Heating Elements

HEATER MODEL	kW	STEAM ROOM (m³)		SIZE OF HEATER (mm)			WEIGHT (kg)	CONTROL
		MIN	MAX	WIDTH	DEPTH	HEIGHT		
STE-90-C1/3	9,0	8	20	555	335	465	23	STE Basic   Advance
STE-120-3	12,0	15	28	555	335	465	23	STE Basic   Advance
STE-150-3	15,0	22	40	555	335	465	23	STE Basic   Advance

2 Heating Elements

HEATER MODEL	kW	STEAM ROOM (m³)		SIZE OF HEATER (mm)			WEIGHT (kg)	CONTROL
		MIN	MAX	WIDTH	DEPTH	HEIGHT		
STN-30-1/2	3,0	3		560	185	485	17	Touch   Classic   Classic 2.0
STN-35-1/2	3,5	3,5		560	185	485	17	Touch   Classic   Classic 2.0
STN-40-1/2	4,0	4		560	185	485	17	Touch   Classic   Classic 2.0
STN-45-1/2	4,5	2	5	560	185	485	17	Touch   Classic   Classic 2.0
STN-50-1/2	5,0	2	6	560	185	485	17	Touch   Classic   Classic 2.0

3 Heating Elements

HEATER MODEL	kW	STEAM ROOM (m³)		SIZE OF HEATER (mm)			WEIGHT (kg)	CONTROL
		MIN	MAX	WIDTH	DEPTH	HEIGHT		
STN-45-3	4,5	2	5	560	220	485	19	Touch   Classic   Classic 2.0
STN-45-C1/3	4,5	2	5	560	220	485	19	Touch   Classic   Classic 2.0
STN-60-3	6,0	3	10	560	220	485	19	Touch   Classic   Classic 2.0
STN-60-C1/3	6,0	3	10	560	220	485	19	Touch   Classic   Classic 2.0
STN-75-3	7,5	4	15	560	220	485	19	Touch   Classic   Classic 2.0
STN-75-C1/3	7,5	4	15	560	220	485	19	Touch   Classic   Classic 2.0

6 Heating Elements

HEATER MODEL	kW	STEAM ROOM (m³)		SIZE OF HEATER (mm)			WEIGHT (kg)	CONTROL
		MIN	MAX	WIDTH	DEPTH	HEIGHT		
STN-90-3	9,0	8	20	560	310	485	23	Touch   Classic   Classic 2.0
STN-90-C1/3	9,0	8	20	560	310	485	23	Touch   Classic   Classic 2.0
STN-120-3	12,0	15	28	560	310	485	23	Touch   Classic   Classic 2.0
STN-150-3	15,0	22	40	560	310	485	23	Touch   Classic   Classic 2.0

## INCLUDED IN THE PACKAGE



STE Basic Control  
(Included for STE models only)



Autodrain  
(Included for STN models only)



Aroma, Fan and Dimmer Functions  
(Optional features for STN models)



Temperature sensor with  
wire and sensor holder



Steam Head



7,5m RJ12 Cable  
7,5m RJ10 Cable



## OPTIONAL ITEMS



Decalcifying Solutions

- » Clears calcium deposits inside steam generator tank
- » 4L, 500ml and 250ml sizes



Aroma Therapy

- » A fragrance for your sauna or steam room
- » 4L, 500ml and 250ml sizes



Aroma Pump



Demand Button



Steam Door  
code: ST-746  
size: 790 x 1890mm



## VENTURI PIPE



Venturi Pipe L-shape



Venturi Pipe Straight

### Venturi Pipe

- » Generate milder and softer steam
- » Create more steam clouds
- » Prevents hissing noise
- » Including steam head to spread the steam outburst
- » Thick stainless metal

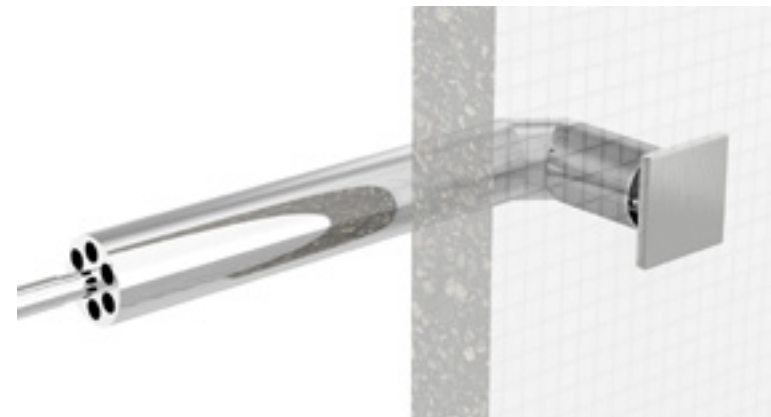

# Sauna ROOMS

Calm your nerves and relief your stress with pleasant heat of the authentic Finnish sauna.



# 2020 Glass Front

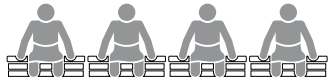

- » Reversible benches, heater location and door opening
- » Clear tempered glass front
- » Vertical door handle
- » Stainless metal legs as bench support
- » Easy to assemble modular sauna room
- » With wiring provisions
- » Best for Round Tower heater
- » Wood: Cedar, Aspen or Spruce
- » Size: 2m x 2m x 2,3m

! Complete set with heater and accessories can be ordered.



Cedar (D)

Aspen (A)

Spruce (S)

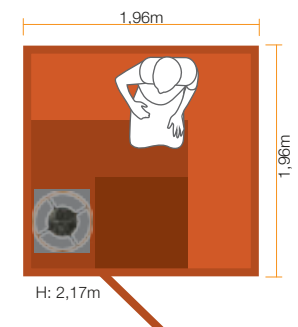

Item Code: 2020MrL-CD-G CEDAR





# 1420 Glass Front

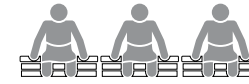

- » Reversible benches, heater location and door opening
- » Clear tempered glass front
- » Vertical door handle
- » Stainless metal legs as bench support
- » Easy to assemble modular sauna room
- » With wiring provisions
- » Best for Round Tower heater
- » Wood: Cedar, Aspen or Spruce
- » Size: 1,4m x 2m x 2,3m

⚠ Complete set with heater and accessories can be ordered.



Cedar (D)

Aspen (A)

Spruce (S)

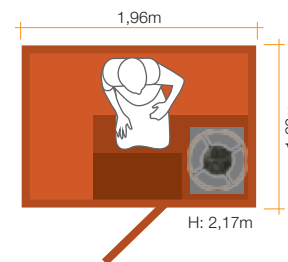

Item Code: 1420MrL-CA-G ASPEN

# 1414 Glass Front

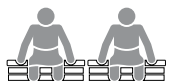

- » Reversible benches, heater location and door opening
- » Clear tempered glass front
- » Vertical door handle
- » Stainless metal legs as bench support
- » Easy to assemble modular sauna room
- » With wiring provisions
- » Best for Wall Tower heater
- » Wood: Cedar, Aspen or Spruce
- » Size: 1,4m x 1,4m x 2,3m

! Complete set with heater and accessories can be ordered.



Cedar (D)

Aspen (A)

Spruce (S)

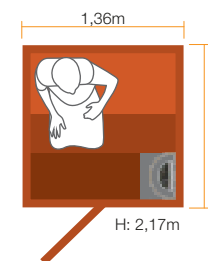

Item Code: 1414RS-CS-G SPRUCE



# STANDARD Sauna Rooms

SAWO sauna rooms are made from the finest softwoods Cedar, Aspen and Spruce and designed with the touch of Finnish traditions and know-how. Each material has their own distinct character which separates them from other.

Available sauna room interior designs for Cedar and Aspen are Wave, Piano and Classic designs. Piano and Classic designs are also available for Spruce sauna rooms.



Cedar (D)



Aspen (A)



Spruce (S)



## TYPES OF BENCHES



» Wave



» Piano



» Classic



# WAVE Bench Sauna

Finland – the land of thousand lakes. The inspiration for Wave design comes from the origin of sauna. The shapes of waves are brought inside sauna room to create relaxing and calm atmosphere.

! Complete set with heater and accessories can be ordered.



Cedar (D)



Aspen (A)

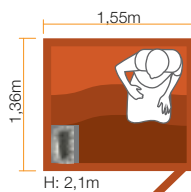

Item Code: 1416RS-WD CEDAR

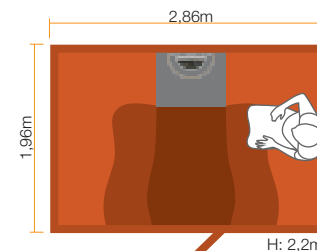

Item Code: 2029MD-WA ASPEN

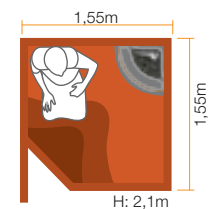

Item Code: 1616LAC-WD CEDAR

# PIANO

## Bench Sauna

This design combines modern and traditional interiors. The name of the design is Piano. Take a look and you can see why.

! Complete set with heater and accessories can be ordered.



Cedar (D)



Aspen (A)



Spruce (S)

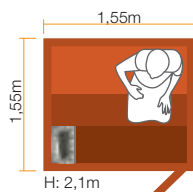

Item Code: 1416RS-PD CEDAR

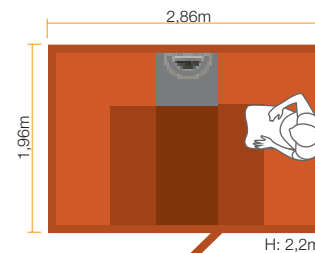

Item Code: 2029MD-PA ASPEN

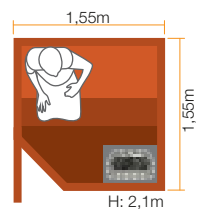

Item Code: 1616LSC-PS SPRUCE



# CLASSIC Bench Sauna

The atmosphere and outlook of Classic design honors Finnish sauna as it has been for ages. Each piece of wood is symmetrically and neatly arranged next to each other. Classic design is simple and beautiful at the same time.

! Complete set with heater and accessories can be ordered.



Cedar (D)



Aspen (A)



Spruce (S)

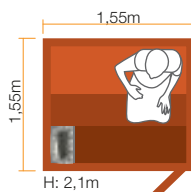

Item Code: 1416RS-CD CEDAR

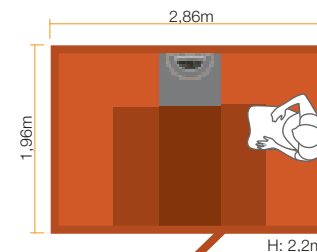

Item Code: 2029MD-CA ASPEN

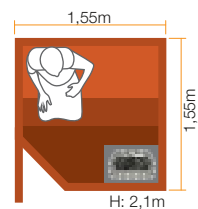

Item Code: 1616LSC-CS SPRUCE

# Standard Layout



## SAUNA ROOM CODING STRUCTURE

<b>00</b>	<b>00</b>	<b>M</b>	<b>S</b>	<b>C</b>
LENGHT	WIDTH	DOOR LOCATION	BENCH DESIGN	ROOM TYPE

### DOOR LOCATION

- L = LEFT
- M = MIDDLE
- R = RIGHT

### BENCH DESIGN

- A = L-type, heater at corner
- D = Double Straight
- L = L-type
- S = Straight
- rL = L-type at right
- lL = L-type at left

### ROOM TYPE

- C = Corner type



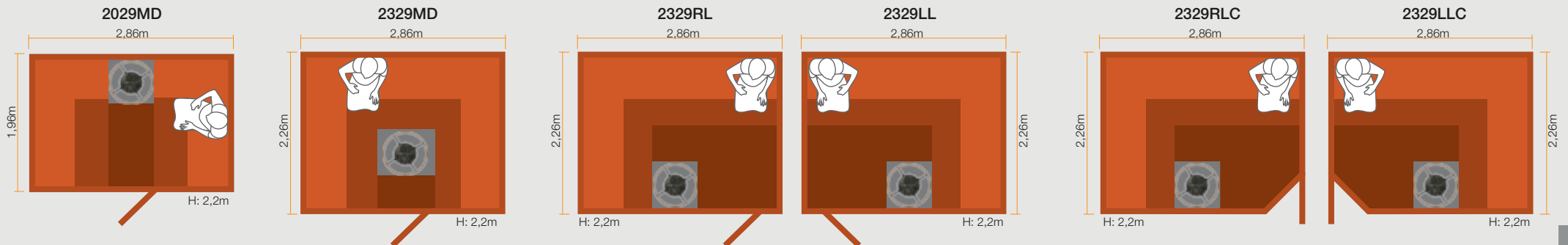
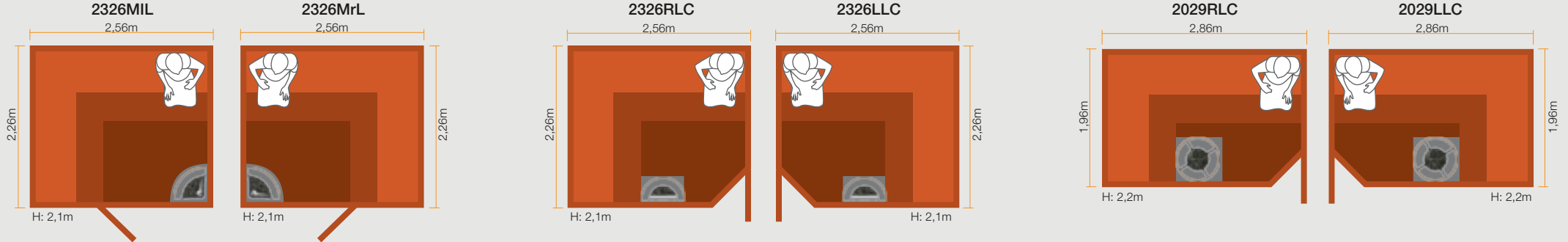
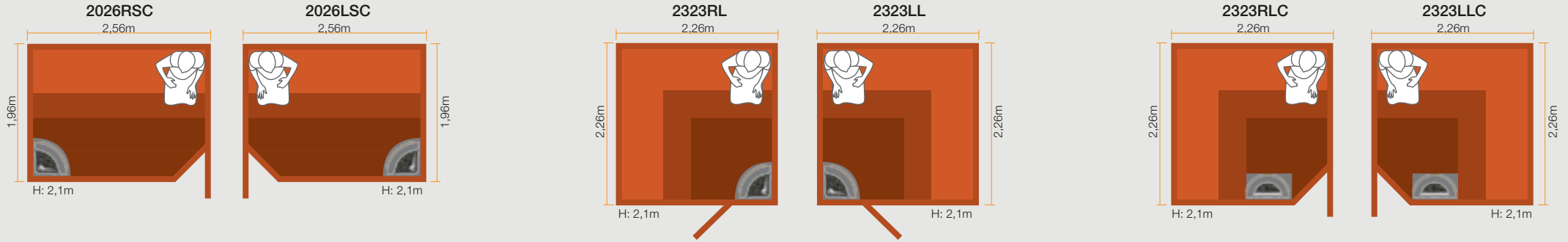
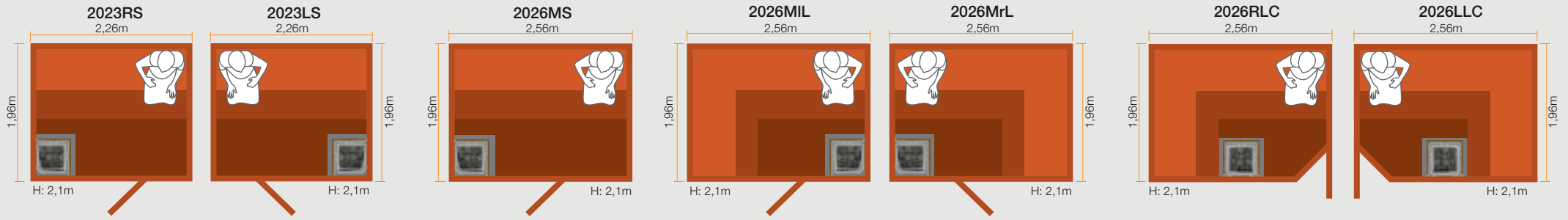



## OPTIONS

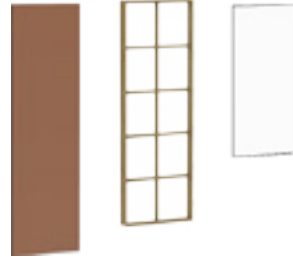

### Extra Glass Windows

- » Sizes
  - 600 x 1800mm
  - 600 x 900mm
  - 400 x 750mm
- » Glass window with grill



### Soapstone Wall

- » Sold per square meter (m<sup>2</sup>)



# OUTDOOR Sauna Rooms

SAWO outdoor saunas are made to last severe weather conditions. Top coated walls and durable asphalt shingle roof protects from sun and rain thus making sauna long-lasting.

! Complete set with heater and accessories can be ordered.

Outdoor Roof



» Asphalt shingles

Sauna Room Top Coat



» With coat

» Without coat

! Other outdoor sauna room sizes can be ordered.



Cedar (D)

Aspen (A)

Spruce (S)

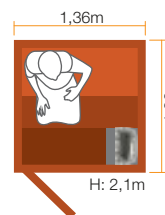

Item Code: 1414LS-GS SPRUCE

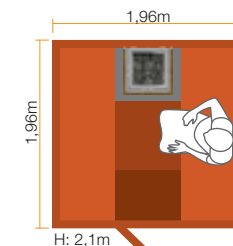

Item Code: 2020MD-CD CEDAR

# CUSTOMIZED Sauna Rooms

Can't find suitable sauna from standard models? No worries! Our skillful and talented sauna specialists can help you to design and fabricate sauna of your dreams. Send us your plans or start sauna creation from the beginning with SAWO team and be ready to be amazed!

⚠ Complete set with heater and accessories can be ordered.



Cedar (D)



Aspen (A)



Spruce (S)

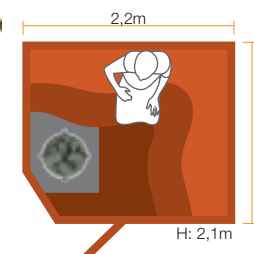
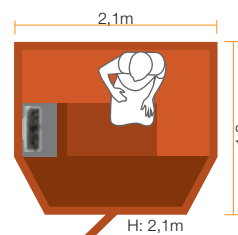
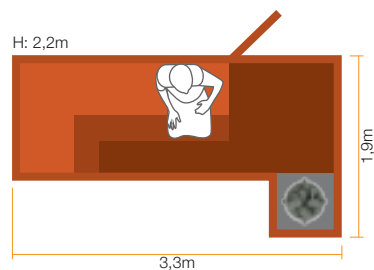



# Infrared Sauna ROOMS

Feel the fullness of well-being with gentle IR wave therapy.

# INFRARED Sauna Room

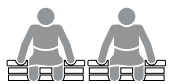

- » Material: Cedar
- » Sturdy 17mm solid cedar wood used in walls and ceiling panels
- » Control: temperature, session time, lights and fan
- » Session time: 1 - 99min
- » Fiber coated far infrared panels (170W / panel)
- » RGB LED lights (10W) with integrated Bluetooth-speaker (3W)
- » Pre-installed exhaust fan (18W)
- » Adjustable base support
- » 230V 1N~ plug and play installation
- » Packing: Wooden crate
- » 2 different sizes:
  - 1-person sauna: 1200 W,  
ext. dimensions: 890mm x 930mm x 2021mm
  - 2-persons sauna: 1400 W,  
ext. dimensions: 890mm x 1080mm x 2021mm



Cedar (D)

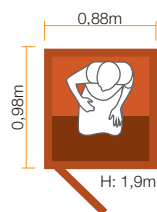

Item Code: IR-1009MS-D

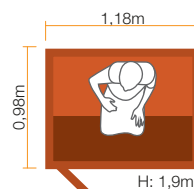

Item Code: IR-1012LS-D

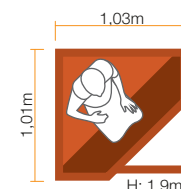

Item Code: IR-1010MSC-D

## OPTIONAL ITEMS



code: IR-PANEL-1



code: IR-PANEL-2

### Infrared Panels

- » Fiber coated infrared panel
- » Ready to connect
- » Use for customized Infrared saunas or as a spare part for standard Infrared sauna rooms



code: 505-IR-A | D  
size: 325 x 843mm  
wood: Aspen | Cedar

code: 517-IR-A | D  
size: 300 x 950mm  
wood: Aspen | Cedar

### Infrared Backrest

- » Plug and play device
- » Aspen or Cedar wood



User Interface  
code: IR-UI-V2



Power Controller  
code: IR-PC-1

### Infrared Control

- » Simple and easy to use
- » Session time up to 99mins
- » Temperature setting 35-75 °C
- » Fan control
- » Light switch



# Sauna ACCESSORIES

Fulfill sauna design with outstanding accessories.







## PAIL & LADLE with Curved handle

Pail and ladle in perfect harmony! The ladle sits effortlessly on the pail's handle.

The smoothing curve shape of the handle represent how calm and relaxing sauna can be.

- » 5 or 3 liter stainless pail
- » Stainless ladle
- » Cedar or Aspen handle



5 Liters Curved Pail  
with Ladle  
(Cedar | Aspen)

3 Liters Curved Pail  
with Ladle  
(Cedar | Aspen)

## THERMOMETERS & HYGROMETERS



code: 100-TBP | TBA  
size: Ø100 x H25mm  
wood: Pine | Aspen



code: 102-HP | HA | HD  
size: Ø100 x H25mm  
wood: Pine | Aspen | Cedar



code: 175-TP | TA | TD  
size: Ø230 x H40mm  
wood: Pine | Aspen | Cedar



code: 230-TP | TA | TD  
size: Ø135 x H30mm  
wood: Pine | Aspen | Cedar



code: 231-THP | THA | THD  
size: Ø 185 x H 30mm  
wood: Pine | Aspen | Cedar



code: 290-HR | TR  
size: Ø110mm  
wood: Soapstone



code: 115-TP | TA | TD  
size: 160 x 185mm  
wood: Pine | Aspen | Cedar



code: 116-THP | THA | THD  
size: 160 x 225mm  
wood: Pine | Aspen | Cedar



code: 125-TP | TA | TD  
size: 180 x 110mm  
wood: Pine | Aspen | Cedar



code: 135-TBP | TBA  
size: 100 x 135mm  
wood: Pine | Aspen



code: 145-TP | TA | TD  
size: 230 x 120mm  
wood: Pine | Aspen | Cedar



code: 105-TBP | TBA  
size: 125 x 125mm  
wood: Pine | Aspen



code: 106-THBP | THBA  
size: 125 x 200mm  
wood: Pine | Aspen



code: 220-TP | TA | TD  
size: 140 x 140mm  
wood: Pine | Aspen | Cedar



code: 223-TP | TA | TD  
size: 140 x 140mm  
wood: Pine | Aspen | Cedar

### Circles



### Cottages



### Box Types



Box Type Thermometer or Hygrometer

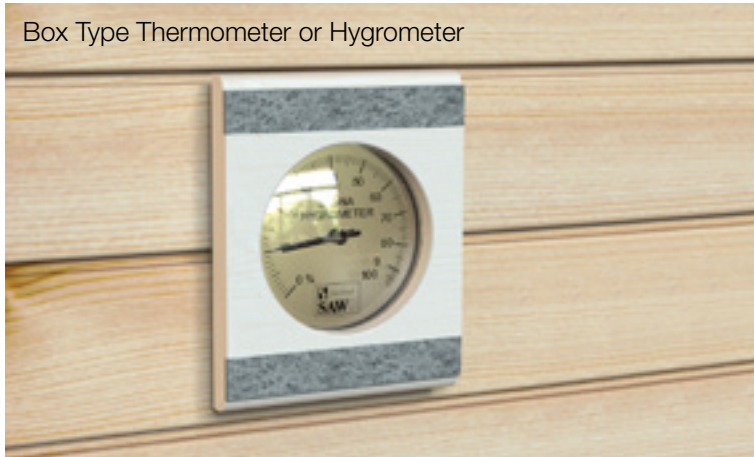

code: 225-THP | THA | THD  
size: 180 x 180mm  
wood: Pine | Aspen | Cedar



code: 280-HRP | HRA | HRD  
size: 125 x 160mm  
wood: Pine | Aspen | Cedar



code: 281-THRP | THRA | THRD  
size: 160 x 185mm  
wood: Pine | Aspen | Cedar



code: 285-THP | THA | THD  
size: 170 x 175mm  
wood: Pine | Aspen | Cedar

Box Type Thermo-hygrometer

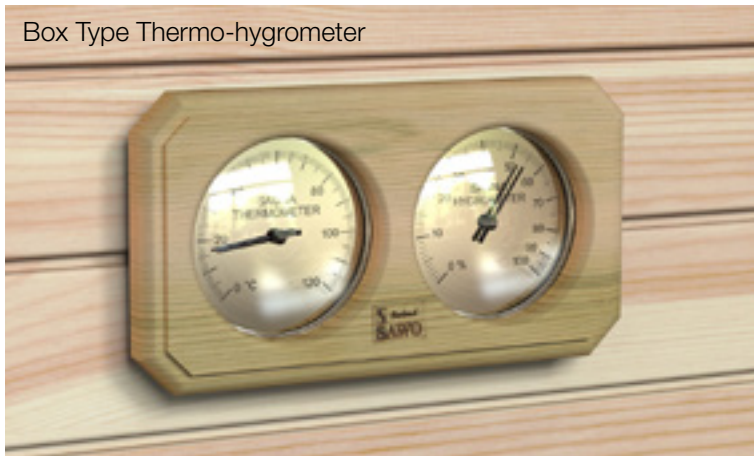

code: 221-THVP | THVA | THVD  
size: 125 x 200mm  
wood: Pine | Aspen | Cedar



code: 221-THP | THA | THD  
size: 225 x 140mm  
wood: Pine | Aspen | Cedar



code: 222-THP | THA | THD  
size: 225 x 140mm  
wood: Pine | Aspen | Cedar



code: 224-THP | THA | THD  
size: 255 x 140mm  
wood: Pine | Aspen | Cedar



code: 271-THBP | THBA | THBD  
size: 225 x 140mm  
wood: Pine | Aspen | Cedar



code: 271-THP | THA | THD  
size: 225 x 140mm  
wood: Pine | Aspen | Cedar



code: 282-THRP | THRA | THRD  
size: 255 x 155mm  
wood: Pine | Aspen | Cedar



code: 283-THRP | THRA | THRD  
size: 155 x 255mm  
wood: Pine | Aspen | Cedar

Miscellaneous Shapes



code: 198-T | TD  
size: 235 x 145mm  
wood: Basswood | Cedar



code: 240-TP | TA | TD  
size: 165 x 180mm  
wood: Pine | Aspen | Cedar



code: 241-THP | THA | THD  
size: 175 x 225mm  
wood: Pine | Aspen | Cedar



code: 250-TP | TA | TD  
size: 150 x 180mm  
wood: Pine | Aspen | Cedar



code: 251-THP | THA | THD  
size: 185 x 225mm  
wood: Pine | Aspen | Cedar

SANDTIMERS



code: 550-P | A | D  
size: 65 x 340mm  
wood: Pine | Aspen | Cedar



code: 550-RP | A | D  
size: 65 x 340mm  
wood: Pine | Aspen | Cedar



code: 551-P | A | D  
size: 65 x 340mm  
wood: Pine | Aspen | Cedar



code: 553-P | A | D  
size: 80 x 340mm  
wood: Pine | Aspen | Cedar



CLOCKS



code: 260-TBP | TBA | TBD  
size: 330 x 135mm  
wood: Pine | Aspen | Cedar



code: 530-P | A | D  
size: Ø260 x H90mm  
wood: Pine | Aspen | Cedar



code: 531-P | A | D  
size: Ø230 x H40mm  
wood: Pine | Aspen | Cedar



code: 300-HP | HA | HD  
capacity: 9L  
wood: Pine | Aspen | Cedar



code: 300-TP | TA | TD  
capacity: 9L  
wood: Pine | Aspen | Cedar



code: 321-MP | MA | MD  
capacity: 2L  
wood: Pine | Aspen | Cedar

PAILS



code: 341-P | A | D  
capacity: 4L  
wood: Pine | Aspen | Cedar



code: 341-MP | MA | MD  
capacity: 3L  
wood: Pine | Aspen | Cedar



code: 371-MP | MA | MD  
capacity: 5L  
wood: Pine | Aspen | Cedar



## PAILS



code: 330-P | A | D  
capacity: 3L  
wood: Pine | Aspen | Cedar



code: 340-TP | TA | TD  
capacity: 4L  
wood: Pine | Aspen | Cedar



code: 343-MA | MD  
capacity: 3L  
wood: Aspen | Cedar



code: 373-MA | MD  
capacity: 5L  
wood: Aspen | Cedar



code: 375-MP | MA | MD  
capacity: 5L  
wood: Pine | Aspen | Cedar



## PAILS



code: 381-P | A | D  
capacity: 18L  
wood: Pine | Aspen | Cedar



code: 381-P-COV |  
A-COV | D-COV  
use: Cover for 381 pail  
wood: Pine | Aspen | Cedar

code: 391-P | A | D  
capacity: 28L  
wood: Pine | Aspen | Cedar



code: 391-P-COV |  
A-COV | D-COV  
use: Cover for 391 pail  
wood: Pine | Aspen | Cedar

code: 392-P | A | D  
capacity: 40L  
wood: Pine | Aspen | Cedar



code: 392-P-COV |  
A-COV | D-COV  
use: Cover for 392 pail  
wood: Pine | Aspen | Cedar



## LADLES



code: 440 | D  
size: 41cm  
wood: Basswood | Cedar



code: 443 | D  
size: 52cm  
wood: Basswood | Cedar



code: 444 | D  
size: 68cm  
wood: Basswood | Cedar





code: 441-MP | MA | MD  
size: 400mm  
wood: Pine | Aspen | Cedar

code: 442-MP | MA | MD  
size: 400mm  
wood: Pine | Aspen | Cedar

code: 445-MP | MA | MD  
size: 465mm  
wood: Pine | Aspen | Cedar

code: 446-MP | MA | MD  
size: 705mm  
wood: Pine | Aspen | Cedar

code: 453-MA | MD  
size: 460mm  
wood: Aspen | Cedar

## LADLES



code: 558-A | D  
size: 130 x 900mm  
wood: Aspen | Cedar

code: 559-A | D  
size: 150 x 900mm  
wood: Aspen | Cedar

code: 560-A | D  
size: 155 x 900mm  
wood: Aspen | Cedar



code: 565-P | A | D  
size: Ø65 x W70mm  
wood: Pine | Aspen | Cedar

code: 566-P | A | D  
size: Ø90 x W50mm  
wood: Pine | Aspen | Cedar

code: 567-P | A | D  
size: 40 x 235mm  
wood: Pine | Aspen | Cedar



code: 568-P | A | D  
size: 260 x 45mm  
wood: Pine | Aspen | Cedar



Round Hinge  
code: 571



Magnetic Door Lock  
code: 574

## DOOR HANDLES



### Bronze Glass Color



code: 730-3SGP | A | D\*  
Glass size: 600 x 1800mm  
Frame size: 690 x 1890mm  
wood: Pine | Aspen | Cedar



code: 730-4SGP | A | D\*  
Glass size: 600 x 1800mm  
Frame size: 690 x 1890mm  
wood: Pine | Aspen | Cedar

## DOOR SETS



DOOR SETS

Clear Glass



code: 730-3SCP | A | D\*  
Glass size: 600 x 1800mm  
Frame size: 690 x 1890mm  
wood: Pine | Aspen | Cedar



code: 730-4SCP | A | D\*  
Glass size: 600 x 1800mm  
Frame size: 690 x 1890mm  
wood: Pine | Aspen | Cedar



code: 731-3SGP | A | D\*  
Glass size: 700 x 1800mm  
Frame size: 790 x 1890mm  
wood: Pine | Aspen | Cedar



code: 731-4SCP | A | D\*  
Glass size: 700 x 1800mm  
Frame size: 790 x 1890mm  
wood: Pine | Aspen | Cedar

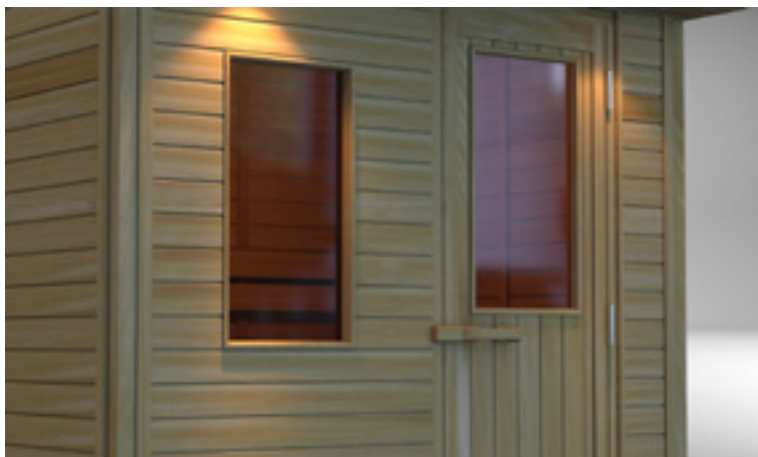

code: 735-4SGU | A | D\*  
Door size: 610 x 1935mm  
Frame size: 700 x 2040mm  
wood: Spruce | Aspen | Cedar



code: 735-4SCU | A | D\*  
Door size: 610 x 1935mm  
Frame size: 700 x 2040mm  
wood: Spruce | Aspen | Cedar

\* Specify when ordering if Left or Right opening.

DOOR SETS



code: 736-4SGU | A | D\*  
 Door size: 915 x 2015mm  
 Frame size: 1005 x 2120mm  
 wood: Spruce | Aspen | Cedar



code: 736-4SCU | A | D\*  
 Door size: 915 x 2015mm  
 Frame size: 1005 x 2120mm  
 wood: Spruce | Aspen | Cedar



code: 739-3SGA | D\*  
 Door size: 915 x 2035mm  
 Frame size: 1005 x 2075mm  
 wood: Aspen | Cedar

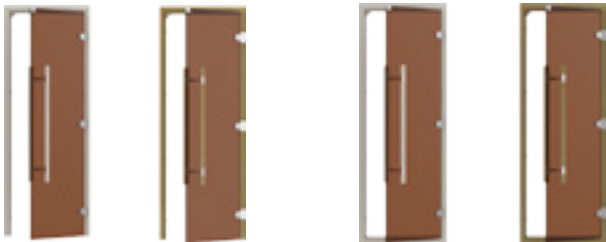

code: 741-3SGA | D\*  
 Glass size: 600 x 1800mm  
 Frame size: 690 x 1890mm  
 wood: Aspen | Cedar

code: 741-4SGA | D\*  
 Glass size: 600 x 1800mm  
 Frame size: 690 x 1890mm  
 wood: Aspen | Cedar



\* Specify when ordering if Left or Right opening.



DOOR SETS

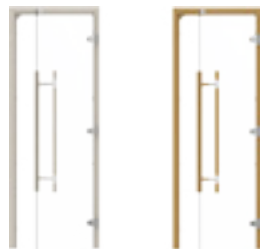

code: 741-3SCA | D\*  
Glass size: 600 x 1800mm  
Frame size: 690 x 1890mm  
wood: Aspen | Cedar



code: 741-4SCA | D\*  
Glass size: 600 x 1800mm  
Frame size: 690 x 1890mm  
wood: Aspen | Cedar



code: 742-3SGA | D\*  
Glass size: 700 x 1800mm  
Frame size: 790 x 1890mm  
wood: Aspen | Cedar



code: 742-4SGA | D\*  
Glass size: 700 x 1800mm  
Frame size: 790 x 1890mm  
wood: Aspen | Cedar

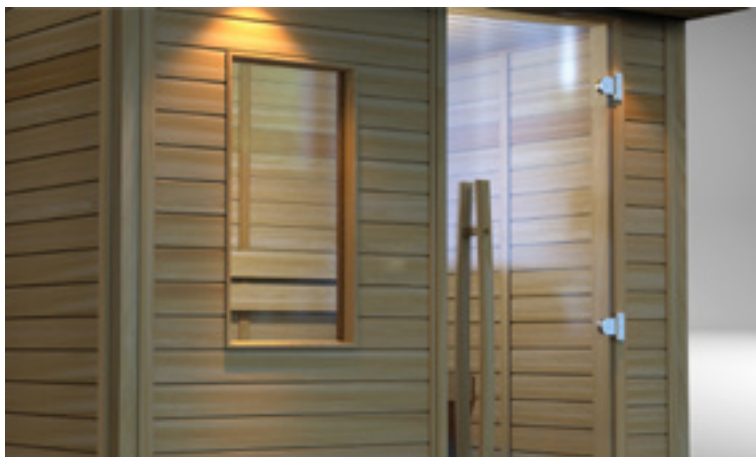

code: 742-3SCA | D\*  
Glass size: 700 x 1800mm  
Frame size: 790 x 1890mm  
wood: Aspen | Cedar



code: 742-4SCA | D\*  
Glass size: 700 x 1800mm  
Frame size: 790 x 1890mm  
wood: Aspen | Cedar

\* Specify when ordering if Left or Right opening.



code: 743-4SGA | D\*  
 Door size: 600 x 1800mm  
 Frame size: 690 x 1890mm  
 wood: Aspen | Cedar



code: 743-4SCA | D\*  
 Door size: 600 x 1800mm  
 Frame size: 690 x 1890mm  
 wood: Aspen | Cedar

\* Specify when ordering if Left or Right opening.

## DOOR SETS



code: 820  
 size: 100 x 200mm



code: 821  
 size: 195 x 110mm



code: 910-SP | SA | SD  
 size: 250 x 75mm  
 wood: Pine | Aspen | Cedar



code: 911-LP | LA | LD  
 size: 250 x 135mm  
 wood: Pine | Aspen | Cedar

## SAUNA LIGHTS & COVERS

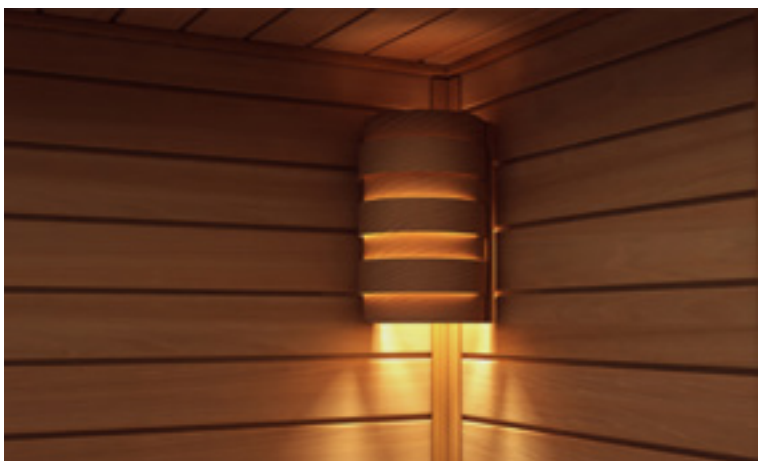

code: 914-VP | VA | VD  
 size: 150 x 110mm  
 wood: Pine | Aspen | Cedar



code: 915-VP | VA | VD  
 size: 207 x 280mm  
 wood: Pine | Aspen | Cedar



code: 917-A | D  
 size: 207 x 280mm  
 wood: Aspen | Cedar



code: 510-P | A | D  
 size: 370 x 295mm  
 wood: Pine | Aspen | Cedar



code: 511-P | A | D  
 size: 370 x 295mm  
 wood: Pine | Aspen | Cedar



code: 512-A | D  
 size: 180 x 230mm  
 wood: Aspen | Cedar



code: 512-RCT-A | D  
 size: 180 x 230mm  
 wood: Aspen | Cedar

## HEADREST



code: 512-SQR-2-A | D  
 size: 250 x 250mm  
 wood: Aspen | Cedar



code: 513-A | D  
 size: 190 x 480mm  
 wood: Aspen | Cedar



code: 515-A | D  
 size: 190 x 480mm  
 wood: Aspen | Cedar

## BACKRESTS, HANGERS & FLOOR MATS



code: 506-2-A | D  
size: 390 x 845mm  
wood: Aspen | Cedar



code: 514-A | D  
size: 346 x 888mm  
wood: Aspen | Cedar



code: 516-P | A | D  
size: 396 x 515mm  
wood: Pine | Aspen | Cedar



code: 517-A | D  
size: 300 x 950mm  
wood: Aspen | Cedar



code: 518-A | D  
size: 300 x 510mm  
wood: Aspen | Cedar



code: 582-P | A | D  
size: 42 x 240mm  
wood: Pine | Aspen | Cedar



code: 583-P | A | D  
size: 42 x 440mm  
wood: Pine | Aspen | Cedar



code: 586-P | A | D  
size: 42 x 340mm  
wood: Pine | Aspen | Cedar



code: 595-P | D-CNR  
size: 390 x 115mm  
wood: Cedar



code: 595-P | D-SID  
size: 285 x 115mm  
wood: Cedar



code: 595-P | D-BLK  
size: 285 x 285mm  
wood: Cedar

## BENCHES & MISCELLANEOUS ITEMS



code: 520-D  
size: 534 x 430 x 400mm  
wood: Cedar



code: 521-D  
size: 870 x 430 x 400mm  
wood: Cedar



code: 522-D  
size: 870 x 500 x 500mm  
wood: Cedar



code: 523-D  
size: 1200 x 500 x 500mm  
wood: Cedar



code: 524-D  
size: 535 x 780 x 850mm  
wood: Cedar



Bottle Opener  
code: 581-P | A | D  
size: Ø80mm  
wood: Pine | Aspen | Cedar



Ventilation Louver  
code: 620-P | A | D  
size: 215 x 170mm  
wood: Pine | Aspen | Cedar



Ventilation Louver  
code: 631-P | A | D  
size: Ø145mm  
wood: Pine | Aspen | Cedar  
ducting hole: 100mm



Ventilation Louver  
code: 634-P | A | D  
size: Ø170mm  
wood: Pine | Aspen | Cedar  
ducting hole: 100mm

## MISCELLANEOUS ITEMS



Sauna Signage  
code: 950-P | A | D  
size: 150 x 80mm  
wood: Pine | Aspen | Cedar



Loud Speaker  
code: 970-A | D  
size: 235 x 355mm  
wood: Aspen | Cedar



Loud Speaker  
code: 971M-A | M-D  
size: 235 x 355mm  
wood: Aspen | Cedar



Loud Speaker  
code: 971BL-A | BL-D  
size: 235 x 355mm  
wood: Aspen | Cedar



Sauna Stones  
code: R-990  
size: 20kg



Decorative Stones  
code: R-992  
size: 32pcs.



Moisture Paper  
code: SP02-900  
size: 2400mm Large

# PAIL Shower

The pail shower is with a rope on the lever, hose and float valve. Its arc shaped holder design gives more possibilities to place shower either on the ceiling or to the wall. Pail shower is suitable for indoor or outdoor use. The hose needs to be connected to a water inlet so when water is flushed out, the pail will automatically be refilled - a never ending pail shower!



code: 393-P | A | D  
capacity: 18L  
wood: Pine | Aspen | Cedar



Wall Installation



Ceiling Installation





# KIVISTONE

Kivistone is a collection of beautiful products carved from Finnish soapstone. Each of these items are uniquely designed for house interiors, household use and for personal or corporate gifts. You will find a vast selection of interesting concepts and designs made of soapstone.

- » Coolers and cooler sets
- » Glasses and holders
- » Aroma cups and scent basins
- » Candle holders
- » Items for kitchen
- » Miscellaneous items



Cooler (4 holes)  
code: R-90  
size: 185 x 185 x 75mm  
weight: 4,1kG



Cooler (2 holes)  
code: R-92  
size: 185 x 100 x 75mm  
weight: 4,1kG



Wine Cooler  
code: R-93  
size: 235 x 60 x 140mm  
weight: 3,2kG



Cooler (1 hole)  
code: R-141  
size: 100 x 100 x 75mm  
weight: 1,3kG



Cooler w/ 2 shot glasses  
code: R-205  
size: 135 x 100 x 70mm  
weight: 1,8kG



Cooler w/ 4 shot glasses  
code: R-206  
size: 190 x 120 x 70mm  
weight: 2,3kG



Glass (ø)50  
code: R-110  
size: 50 x 50 x 60mm  
weight: 0,2kG



Glass (ø)70  
code: R-111  
size: 70 x 70 x 60mm  
weight: 0,4kG



Glass (ø)75  
code: R-112  
size: 75 x 75 x 122mm  
weight: 1kG



Glass (ø)35  
code: R-200  
size: 35 x 35 x 60mm  
weight: 0,1kG



Glass Holder w/ 5 shot glasses  
code: R-300  
size: 235 x 60 x 30mm  
weight: 1,5kG



Glass Holder w/ 5 shot glasses  
code: R-301  
size: 280 x 60 x 30mm  
weight: 1,8kG



Aroma Cup (ø)50  
code: R-100  
size: 50 x 50 x 60mm  
weight: 0,3kG



Scent Basin  
code: R-120  
size: 110 x 110 x 75mm  
weight: 1,3kG



Scent Warmer  
code: R-123  
size: 75 x 75 x 80mm  
weight: 0,7kG



Luxury Aroma Cup (ø)50  
code: R-160  
size: 50 x 50 x 50mm  
weight: 0,2kG



Aroma Spirit Cup  
code: R-501  
size: 75 x 75 x 120mm  
weight: 0,7kG

## KIVISTONE COOLERS & COOLER SETS



## KIVISTONE GLASSES & HOLDERS



## KIVISTONE AROMA CUPS & SCENT BASINS



## KIVISTONE CANDLE HOLDERS



Tower set of 6  
code: R-95  
size: 360 x 60 x 240mm  
weight: 7,4kG



Round Candle Holder (ø)75  
code: R-101  
size: 75 x 20mm  
weight: 4,2kG



Candle Holder Straight 5  
code: R-105  
size: 265 x 60 x 30mm  
weight: 1kG



Candle Holder Square 9  
code: R-106  
size: 200 x 200 x 45mm  
weight: 3kG



S-type Candle Holder set of 3 (short)  
code: R-107 (set,3pcs.)  
size: 180 x 60 x 240mm  
weight: 4,9kG



S-type Candle Holder set of 3 (long)  
code: R-108 (set,3pcs.)  
size: 180 x 60 x 240mm  
weight: 6,2kG



code: Candle Holder Bridge  
size: R-109  
weight: 110 x 60 x 55mm  
0,6kG



Candle Holder Boat  
code: R-115  
size: 110 x 60 x 45mm  
weight: 0,6kG



Spiral Candle Holder set of 3  
code: R-180  
size: 180 x 60mm  
weight: 4,2kG

## KIVISTONE ITEMS FOR KITCHEN



Plate w/ 3 shot glasses  
code: R-151  
size: 240 x 170 x 35mm  
weight: 2,9kG



Plate Small  
code: R-152  
size: 240 x 170 x 25mm  
weight: 2,6kG

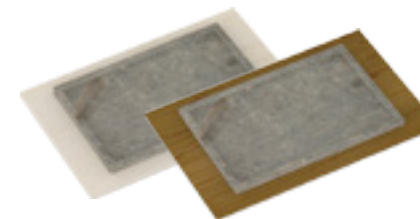

Plate w/ wooden tray  
code: R-153 A | D  
size: 400 x 250 x 37mm  
weight: 2,7kG  
wood: Aspen | Cedar



Chopstick Holder  
code: R-401  
size: 50 x 15 x 15mm  
weight: 0,1kG



Coaster Stone  
code: R-403  
size: 90 x 90 x 60mm  
weight: 0,9kG

## KIVISTONE MISCELLANEOUS ITEMS



Soap Holder  
code: R-116  
size: 180 x 100 x 30mm  
weight: 0,9kG



Photo Frame (Small)  
code: R-165  
size: 150 x 45 x 135mm  
weight: 0,9kG



Photo Frame (Large)  
code: R-170  
size: 170 x 90 x 145mm  
weight: 1,3kG



Card Holder  
code: R-402  
size: 110 x 40 x 55mm  
weight: 0,5kG



Ashtray  
code: R-407  
size: 60 x 50 x 60mm  
weight: 0,7kG



Whiskey Stones  
code: R-996  
size: 85 x 65 x 25mm  
weight: 0,3kG



[www.sawo.com](http://www.sawo.com)